

# TE 100

## 高精度回路电阻测试仪

High Precision High Current Microhmmeter

# 说明书

## USER MANUAL

### 武汉特试特科技有限公司

WUHAN TESTYLE TECHNOLOGY CO., LTD.

---

地址: 武汉市东湖高新技术开发区关山二路

特1号国际企业中心II-2

免费服务热线: 800-880 0780

电话: (027)6784 5315、6784 5317 传真: (027)6784 5319

网址: <http://www.500kv.com>

E-MAIL: [sales @ testyle.cn](mailto:sales@testyle.cn)

Address: International Enterprises Center II, Guan Shan Road II, East Lake  
High-tech Development Zone, Wuhan

Free Service Hotline: 800-880 0780

TEL: +86-27-6784 5315、+86-27-6784 5317 Fax: +86-27-6784 5319

Website: [www.hvtester.com](http://www.hvtester.com)

E-MAIL: [sales @ testyle.cn](mailto:sales@testyle.cn)

一、衷心感谢您使用本公司的产品，您因此将获得本公司全面的技术支持和服务保障。

Firstly, we would like to express our heartfelt thanks for your choosing our product. You will receive overall technical support and service guarantee from our company.

二、本使用说明书适用于TE100高精度回路电阻测试仪。

Secondly, this manual book is designed for TE100 High Precision High Current Microhmmeter.

三、当您在使用本产品前，请仔细阅读本使用说明书，并妥善保存以备查考。

Thirdly, before you use this product, please read this manual book carefully and keep it for reference.

四、请严格按说明书要求步骤操作，使用不当可能危及人身安全。

Fourthly, follow the steps strictly, any wrong operating can affect the personal safety.

五、在阅读本说明书或仪器使用过程中如有疑问，可向我公司咨询。

咨询电话：+86-800-8800780, +86-27-67845315

Fifthly, if you have any question when you read this manual book or use the equipment, please feel free to contact us.

**Hotline:** +86-800-8800780, +86-27-67845315

|        |   |   |
|--------|---|---|
| 1、概述   | General Introduction                              |   |
| 1. 1   | 用途 Application                                    | 1 |
| 1. 2   | 性能特点 Function and Feature                         | 1 |
| 2、特别提示 | Special Note                                      |   |
| 2. 1   | 电源方面 Power Supply                                 | 3 |
| 2. 2   | 安全方面 Security                                     | 3 |
| 2. 3   | 操作方面 Operation                                    | 3 |
| 3、技术特征 | Technical Feature                                 |   |
| 3. 1   | 名称和分类 Name and Classification                     | 5 |
| 3. 2   | 主机结构形式与尺寸<br>Structure and Dimension of Body Part | 5 |
| 3. 3   | 使用电源 Power  | 5 |
| 3. 4   | 使用环境要求 Environment Requirement                    | 5 |
| 3. 5   | 仪器功率 Instrument power frequency                   | 6 |
| 3. 6   | 测量范围 Measurement Range                            | 6 |
| 3. 7   | 测量精度 Measurement Accuracy                         | 6 |
| 3. 8   | 最高分辨率 Maximum resolution                          | 6 |
| 3. 9   | 测试电流 Test current                                 | 6 |
| 3. 10  | 测试时间 Test time                                    | 6 |
| 4、工作原理 | Working Principles                                |   |
| 4. 1   | 原理框图 Principle Diagram                            | 7 |
| 5、面板布置 | Panel Layout                                      |   |
| 5. 1   | 面板示意图 Panel Sketches                              | 8 |
| 5. 2   | 各部件说明 Illustration                                | 8 |

## 目录

**Contents**

|   |                                   |       |    |
|---|-----------------------------------|-------|----|
| 5. 3 按键说明                                       | Button Instruction                | ----- | 9  |
| 6、页面说明 Page Instruction                         |                                   |       |    |
| 6. 1 开机页面                                       | Start Page                        | ----- | 9  |
| 6. 2 主菜单  | Main Menu                         | ----- | 10 |
| 6. 3 测试菜单                                       | Test Menu                         | ----- | 10 |
| 6. 4 数据菜单                                       | Date Menu                         | ----- | 11 |
| 6. 5 数据打印页面                                     | Date printing page                | ----- | 12 |
| 6. 6 数据存储页面                                     | Data storage page                 | ----- | 13 |
| 6. 7 输入法页面                                      | Input method page                 | ----- | 14 |
| 6. 8 数据读取页面                                     | Data reading page                 | ----- | 15 |
| 6. 9 设置页面                                       | page settin                       | ----- | 16 |
| 6. 10 帮助页面                                      | Help page                         | ----- | 19 |
| 7、基本操作 Basic Operation                          |                                   |       |    |
| 7. 1 如何更换打印纸                                    | How to replace the printing paper | ----- | 21 |
| 7. 2 如何更换保险丝                                    | How to replace the fuse           | ----- | 21 |
| 8、测试 Test                                       |                                   |       |    |
| 8. 1 接线准备                                       | Connection preparation            | ----- | 22 |
| 8. 2 测试步骤                                       | Test steps                        | ----- | 22 |
| 8. 3 试验结束后现场清理                                  | On-site cleanness after testing   | ---   | 23 |
| 9、运输与保养 Transportation and Maintenance ----- 24 |                                   |       |    |
| 1 0、随机配件 Accessories ----- 25                   |                                   |       |    |
| 1 1、售后服务 After-sale Service ----- 26            |                                   |       |    |

---

## 目录

### Contents

## 1.1 用途 Application

TE100 高精度回路电阻测试仪适用于高压开关接触电阻（回路电阻）的高精度测量，同样适用于其它需要大电流、微电阻测量的场合。

TE100 High Precision High Current Microhmmeter is applicable to high-precision measurement of high-voltage switch contact resistance (loop resistance), and to other fields needing high current micro-resistance as well.

## 1.2 性能特点 Performance Characteristics

(1) **大电流**：采用最新电源技术，能长时间连续稳定输出大电流，克服了脉冲式电源只能瞬间输出电流的弊端，可以有效的击穿开关触头氧化膜，得到良好的测试结果。

(1) **High current**: Adopt up-to-date power supply technology, output high current continuously for a long time, overcome the shortage of pulse-power transient current, effectively break down oxide film of switch contact, and obtain good test results.

(2) **抗干扰能力强**：在严重干扰条件下，最后一位数据能稳定在 $\pm 1$ 个字。读数稳定，重复性好。

(2) **Strong anti-interference capability**: under severe interference, the last digit in a sequence can be fixed around  $\pm 1$  digit. The reading is stable and the repeatability is good.

(3) **智能化高**：本仪器采用32位CPU，具有日期时钟、自动打印、数据存储功能，能存贮100组数据，便于对历史数据的保存及跟踪分析。输出电流与输出时间可由菜单操作选择，无需调压器或电位器调整，无机械性故障。

(3) **High intelligence**: This instrument adopts 32-bit CPU, is functioned by date and clock, automatic printing and data storage, can store 100 groups of data, and is convenient for the storage and follow-up analysis of historical data. Output current and output time can be selected through Menu operation, without adjusting voltage regulator or potentiometer and no mechanical failure.

(4) **使用方便**：操作界面友好，测量数据显示结果直观，内置的前换纸打印机能以中文模式打印记录数据，换纸更加方便。

(4) **Easy to use**: Operation interface is friendly, the indication of measured data is visual, built-in front paper-change printer can print record data in Chinese, and it is easier to change paper.

# 1

## 概述 Overview

(5) **使用寿命长：**采用宽温型汉字液晶显示器，解决了高温及太阳直射环境下液晶显示器易失效的问题。全部采用高精度电阻，有效的消除环境温度对测量结果的影响，军品接插件的使用增强了抗振性能。

(5) **Long durability:** Use wide-temperature Chinese LCD, and solve the problem that LCD is easily out of work under high temperature and direct sunlight. High-precision resistance is total adopted and effectively eliminates the effect of ambient temperature on test result, and the use of military connector strengthens vibration resistance.

(6) **携带方便：**体积小、重量轻。

(6) **Portable:** Small volume and light weight.

# 1

## 概述 Overview

## 2.1 电源方面 Power supply

- (1) 本仪器使用交流220V电源。
- (1) AC220V power supply

## 2.2 安全方面 Security

- (1) 为了仪器及操作人员的安全，仪器必须可靠接地。
- (1) For the purpose of safety of instrument and the operator, instrument must be grounding reliably.
- (2) 试验准备时最先接好地线，工作完毕时，最后拆除接地线。
- (2) You must connect the grounding first during the test preparation and remove the grounding in the end after completion.
- (3) 在通电情况下，任何人不得插拔任何接线。
- (3) Under the condition of power on, no one is allowed to plug or pull out any connecting line.
- (4) 当在室外时，请勿将仪器长时间置于太阳下曝晒。
- (4) When doing outdoor work, please don't put the instrument under the sun for a long time.

## 2.3 操作方面 Operation

- (1) 仪器面板与测试线的连接处应钮紧，不得有松动现象。
- (1) The connection between panel and test wire should be buttoned closely, and the looseness is not allowed.
- (2) 应按照四端子法接线，即电流线应夹在被试品的外侧，电压线应夹在被试品的内侧。
- (2) Four-terminal method should be adopted to connecting wire; In other words, current wire should be clamped to the outer side of the specimen, and voltage wire should be clamped to its inner side.
- (3) 被试品引出线处如有生锈、油漆等，会因接触不良导致不能正确升流，如出现“过量程”，测试结果为偏大等现象应重点检查。
- (3) Rust, paint and others at the outlet of the specimen may result in incorrect upward flow due to loose contact. For example, if “Overrange” appears and test result is “2000 $\mu\Omega$ ”, inspection should be carried out specially.

## 2

### 特别提示 Special Note

(4) 保证开关处于闭合状态。

(4) The switch must be always under closure.

(5) 接线完毕后，应检查一遍，看看是否有接线错误。

(5) After connecting wires, check whether the error exists.

(6) 测试过程中，如出现异常现象，应立即关闭电源，检查接线。

(6) During the test, if the abnormality appears, cut off power supply immediately, and then check connection wire.

## 2

### 特别提示

#### Special Note



### 3.1 名称和分类 Name&Type

- (1) 名称：TE100 高精度回路电阻测量仪。
- (1) Name: TE100 High Precision High Current Microhmmeter.
- (2) 环境组别：属GB6587.电阻1-86《电子测量仪器环境试验总纲》中的III组仪器（即可在室外环境使用）。
- (2) III-group instrument specified in GB6587. Resistance 1-86 Environmental Tests Program for Electronic Measuring Instruments (applicable outdoors).

### 3.2 主机结构型式与尺寸

#### 3.2 Dimensions and Weight of the host

- (1) 型式：一体化便携式
- (1) Type: Integration portable type
- (2) 外形尺寸：长330mm\*宽260mm\*高140mm
- (2) Boundary dimension: Length 330mm\* width260mm\*height140mm
- (3) 质量：5Kg（不含附件）
- (3) Weight: 5Kg(excluding accessories)

**3**

**技术特征**  
**Technical features**

### 3.3 使用电源 Power

- (1) 电压：AC 220V±10%
- (1) Voltage: AC220V±10%
- (2) 频率：50Hz±1Hz
- (2) Frequency: 50Hz±1Hz

### 3.4 使用环境要求 Environment Requirement

- (1) 环境温度：-10℃~40℃
- (1) Environment Temperature: -10℃~40℃
- (2) 相对湿度：≤80%
- (2) Relative humidity: ≤80%

### 3.5 仪器功率 Instrument power frequency

本仪器的额定功率 < 1200W。

The Instrument power frequency < 1200W.

### 3.6 测量范围 Measurement Range

$0\mu\Omega \sim 6000\mu\Omega$

### 3.7 测量精度 Measurement Accuracy

本仪器的测量精度为  $\pm (1\% \times \text{读数} + 2\mu\Omega)$ 。

The instrument's Measurement Accuracy is  $\pm (1\% \times \text{readings} + 2\mu\Omega)$ .

### 3.8 最高分辨率 Maximum resolution

本仪器的最高分辨率为  $0.01\mu\Omega$ 。

The instrument's maximum resolution is  $0.01\mu\Omega$ .

### 3.9 测试电流 Test current

本仪器的测试电流分别为 50A、100A 两档。

The test current of the instrument is 50A and 100A two shifts.

### 3.10 连续输出电流时间 Time of continuous output current

50A: 10s ~ 600s

100A: 10s ~ 60s

## 3

## 技术特征

### Technical features

### 4.1 内部结构 Operational Principle

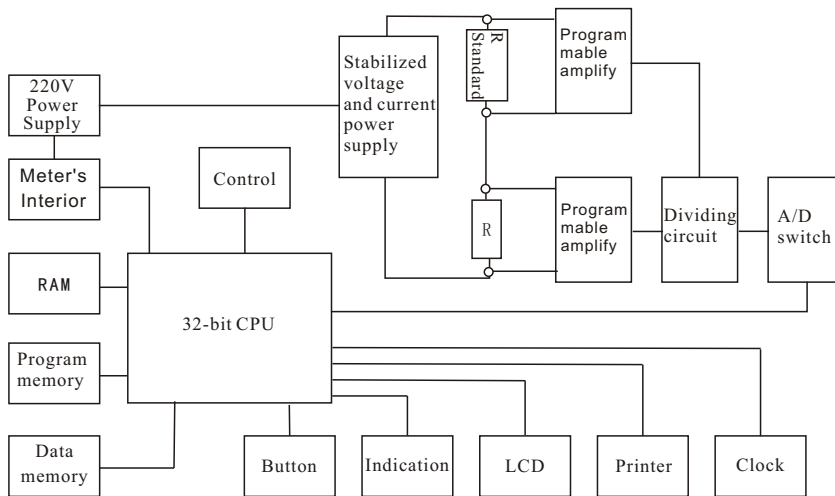
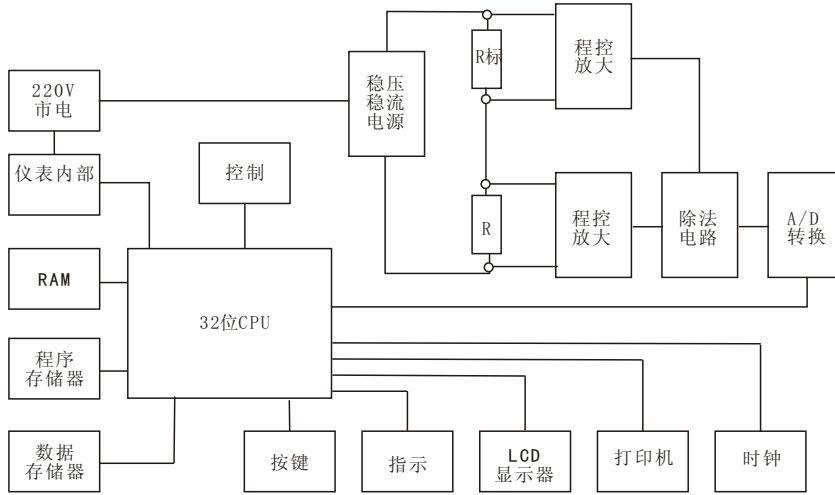

## 4

### 工作原理

### Operating Principle

## 5.1 面板示意图 Panel Schematic diagram

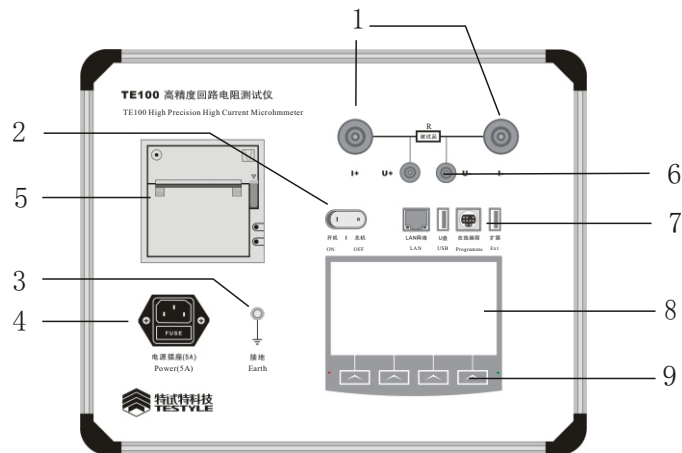

## 5.2 各部件说明

(1) 电流输出端子：与测试电缆中粗的那根相接，对试品输出 50 A、100 A 电流。

(1) Current output terminal: It is connected to the thicker testing cable and outputs 50 A/100 A current to the tested products.

(2) 电源开关：闭合该开关，仪器处于通电状态。

(2) Power switch: This instrument will be electrified by closing this switch.

(3) 接地柱：为保障操作者的安全及仪器正常工作，使用前应将该接线端子可靠接地。

(3) Earth pole: Connection terminal shall be earthed reliably before use in order to guarantee safety of operators and normal operation of instrument.

(4) 电源插座：接 220 V 市电，该插座内含保险丝盒，本仪器应安装 5 A 保险丝。

(4) Power socket: It is electrified by 220V commercial power and contains a fuse box inside. 5A fuse should be installed in this instrument.

(5) 打印机：前换纸型中文打印机，用于测试数据的记录。

(5) Printer: It is a front paper-change printer and used to record testing data.

(6) 电压输入端子：与测试电缆中细的那根相接，测量试品上的压降。

(6) Voltage input terminal: It is connected to the thinner testing cable to test voltage drop of the tested products.

## 5 面板布置 Panel Layout

(7) 通讯接口：网口, U盘, 在线编程, 扩展等通讯接口。

(7) Communication interface: Ethernet port, U disk, online programming, expansion and other communication interfaces.

(8) 液晶显示器：超大屏显示图片菜单及中文显示测试结果。

(8) LCD: It is a large display showing picture menu and testing results in Chinese.

(9) 触摸按键：详见5.3。

(9) Touch Button: See 5.3 for details.

### 5.3 按键说明 Button Instruction

仪器有四个按键，每个按键对应正上方屏幕显示的相应功能菜单，按下后，该功能生效。

Instrument has four buttons, each button corresponding to the corresponding screen display above the function menu, functional effect after press.

### 6.1 开机页面 Start Page

打开电源开关，仪器显示欢迎页面：

Turn on the power switch, and the instrument displays the welcome page.



开机几秒钟进入主菜单。

Boot a few seconds to enter the main menu.

## 6.2 主菜单 Main Menu

仪器开机几秒钟后，仪器显示主菜单：

After a few seconds of the instrument powered, the main menu displays:

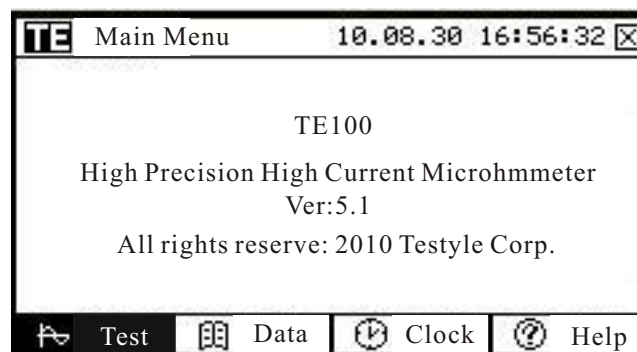

# 6

## 页面说明

Page Instruction

按下功能菜单正下方的按键，该功能生效，进入该功能页面。

Press the function menu buttons just below, which is in effect, to enter the feature page.

## 6.3 测试菜单 Test menu

在主菜单中按下“测试”功能按键，仪器进入测试页面：

In the main menu, press the "test" function keys, the instrument entry into the test page

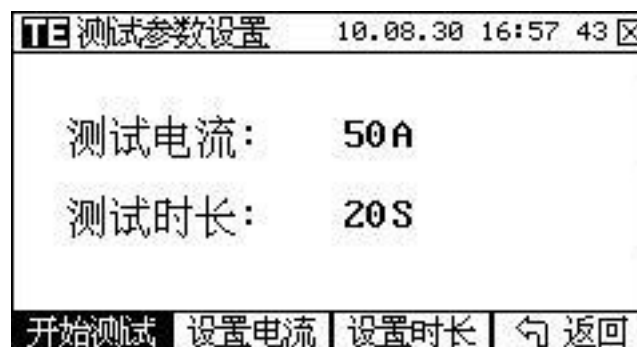

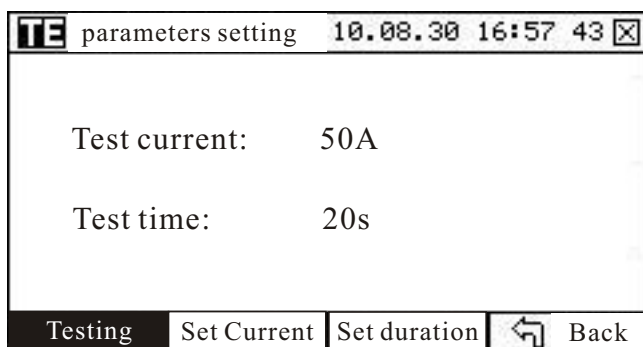

在此页面，按“设置电流”功能按键，可更改电流，电流可更改为50A或100A，可循环更改。

On this page, click "Set Current" function buttons to change the current, current can be recycled changed to 50A or 100A.

按“设置时长”功能按键，可更改测试时长，时间最长可设置为600S，最短为10S，可循环更改。

Click "Set duration" function button to change the test duration, the longest time can be set to 600S, the shortest 10S, can be recycled to change.

按“返回”功能按键，返回主菜单页面。

Press the "Back" function keys, return to the main menu page.

设置好测试电流及测试时间后,可按“开始测试”功能按键进行测试，测试完成后，显示数据页面。

After set well the test current and test time, the instrument can start to test according to the "Start Test" function keys, when completed, which displays the data page.

## 6

### 页面说明

#### Page Instruction

#### 6.4 数据菜单 Data menu



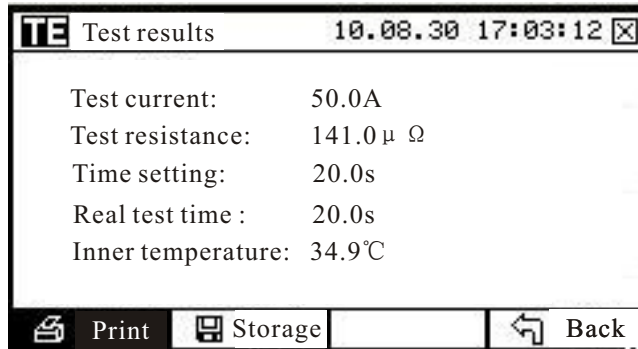

在此页面，可对该数据进行打印或存储。

In this page, the data can be printed and stored.

按“返回”功能菜单，返回“测试”页面。

Press the “Back” button to return to the test page.

## 6 6.5 数据打印菜单 Data print menu

### 页面说明

#### Page Instruction

在6.4数据菜单中，按“打印”功能按键，仪器显示数据打印菜单：

In the 6.4 data menu, to press the PRINT button, the instrument displays print menu.

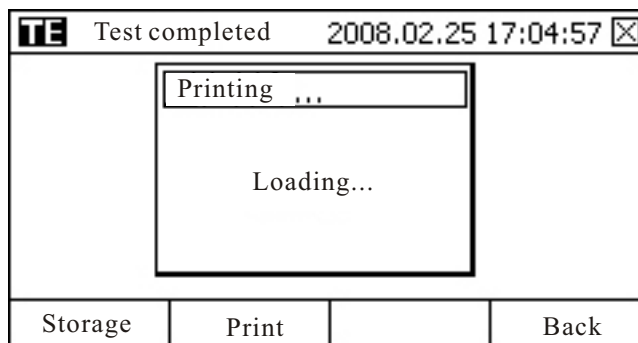
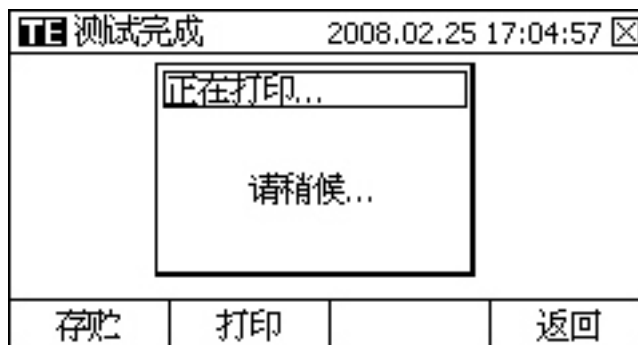



数据打印完成后，按“返回”功能按键返回测试菜单。

Data printed, press “Back” button to return to the test menu.

## 6.6 数据存储菜单 Data storage menu

在6.4数据菜单中，按“存储”功能按键，仪器显示数据存储菜单：

In 6.4 data menu, press “store” button, the instrument displays storage menu.

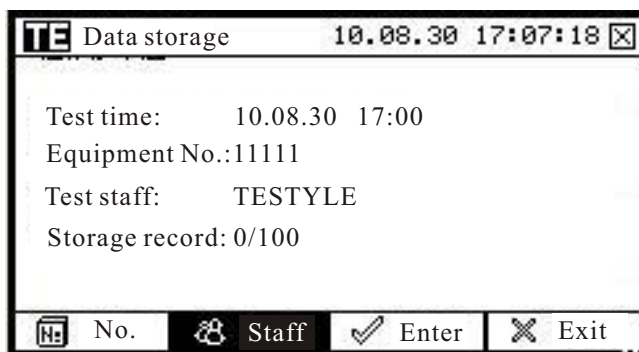

菜单解释：按“编号”功能按键，进入“输入法”界面，在输入法界面，可输入试品编号；

Menu explanation: According to "No" button, enter the "Input Method" interface, the input interface, enter the test sample No.

按“人员”功能按键，进入“输入法”界面，在输入法界面，可输入试品编号；“输入法”界面见下一节介绍；

Press the “ staff ” button, and entry into the input method page, in which you can input the product No., about the input method details, please see the next chapter.

输入试品设备编号及测试人员后，按“确定”功能按键，存贮数据并返回6.4数据菜单。

After input the equipment No. and staff, press the “Enter” button to save the data and back the 6.4 data menu.

## 6.7 输入法菜单 Input method page

在“数据存储”页面，按“编号”或“人员”功能按键后，进入“输入法”页面：

In data storage page, press the No., or staff button, and entry into the input method page.

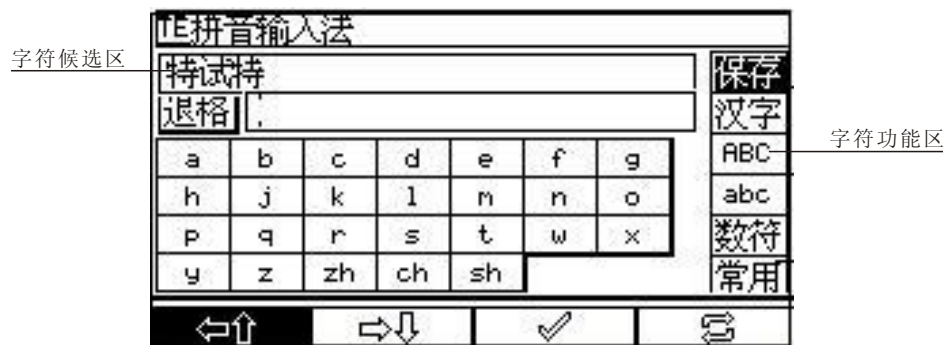













## 6

## 页面说明

### Page Instruction







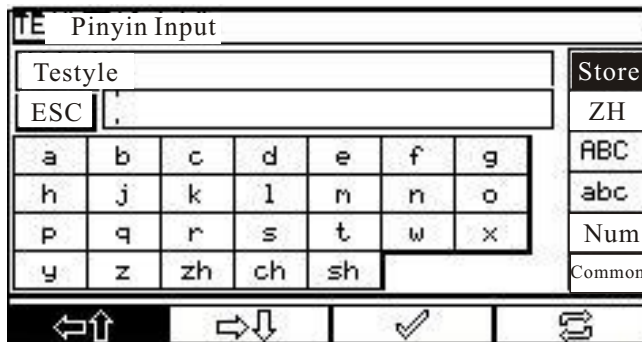









在输入法页面可以输入汉字、大小写字母、数符、及常用词组。此处以输入汉字“特”为例讲解输入法页面：

按“ ”键光标移动到“退格”功能，退格功能可以对字符候选区的字符进行删除；再按“功能”键，光标移动到保存，按“ ”键选择“汉字”功能，此时按“ ”键界面切换至汉字功能页面（进入输入法页面时，系统默认为汉字功能页面，当需要输入其它字符时，可用此方法进行功能切换），按“ ”及“ ”键选择“t”，然后按“ ”键，进入声母“t”拼音界面，按“ ”及“ ”键选择“te”拼音，然后按“ ”键，进入拼音“te”的汉字列表，按“ ”及“ ”键选择“特”字，按“ ”键，汉字“特”便在字符候选区，如输入错误，可按“ ”键切换至“退格”功能，按“ ”键进行删除；如输入正确，按 键切换至“保存”功能，按“ ”键保存并返回数据存储页面。

在数据存储页面，按“确认”键，仪器存储该条测试数据并返回主菜单页面。



In input method page, you can input the Chinese characters, Uppercase and lowercase letters, number of characters and commonly used phrases. Here we take Chinese character “特” as an example:

Press "  " cursor to "backspace" function, the character backspace function can delete characters in the candidate region. Then press Function button cursor moves to storage, press  to select the Chinese characters Function, press  button page switch to Chinese characters Function (when entry into the input page, the system default page for the character features, when the need to enter other characters, this method can be used for functional switching), press " " and " " to choose "t", then press " ", and entry into letter T pinyin page, press " " and " " to choose "te" pinyin, then press " " And entry into pinyin "te" Chinese characters list, press " " and " " to choose "特", press " ". Chinese character "特" characters will be in the candidate areas, if input error, press "  " button, press " " to delete. If input correct, press  button to storage function, and press  to store and back to data storage page.

In the data storage page, click "ENTER" button, the instrument will store the test data and return to the main menu page.

## 6.8 数据读取菜单 Data reading page

在6.2主菜单中，按“数据读取”功能按键，仪器显示数据读取菜单：

In 6.2 main menu page, press the data reading button, the instrument will display reading data menu.

|                |       |      |                   |   |
|----------------|-------|------|-------------------|---|
| TE 数据读取 001    |       |      | 10.08.30 17:08 39 | ⊗ |
| 测试时间           | 设备编号  | 测试人员 |                   |   |
| 10.08.30 17:00 | 11111 | 特试特  |                   |   |
|                |       |      |                   |   |
|                |       |      |                   |   |
|                |       |      |                   |   |
|                |       |      |                   |   |
| ↑              | ↓     | ✓    | ↶                 |   |

|                     |               |            |                   |   |
|---------------------|---------------|------------|-------------------|---|
| TE Data reading 001 |               |            | 10.08.30 17:08 39 | ⊗ |
| Test time           | Equipment No. | Test staff |                   |   |
| 10.08.30 17:00      | 11111         | 特试特        |                   |   |
|                     |               |            |                   |   |
|                     |               |            |                   |   |
|                     |               |            |                   |   |
|                     |               |            |                   |   |
| ↑                   | ↓             | ✓          | ↶                 |   |

- 6** (1) 按“↑”或“↓”功能按键，选择该条数据，按“✓”功能按键，查看该条数据。

## 页面说明

### Page Instruction

Press “↑”or“↓” button to choose the data, press to read the data.

- (2) 在查看数据页面，可以对数据进行打印或删除。按“打印”功能按键，打印数据；按“删除”功能按键，删除该数据。按“↶”功能按键，仪器返回读取数据菜单。

In reading data page, you can carry on print and delete. Press the PRINT button to print and press DELETE button to delete. Press ↶ button to back to the reading data menu.

## 6.9 设置菜单 Setting menu

在6.2主菜单中，按“设置”功能按键，仪器显示设置菜单页面：

In 6.2 main menu, press SETTING button, the instrument will display the main menu.

选择“设备编号库维护”与“测试人员入库维护”可以录入一些经常用到的试品编号与被试人员姓名，方便测试完成后进行数据管理。

Select "Equipment ID database maintenance" and "operator entry into the database maintenance " can input a number of frequently used test product number and name of the operator, it is very convenient for data management after complete the test.

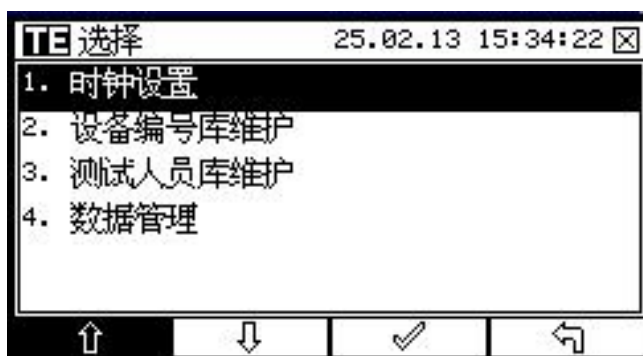

- 1.时钟设置: Time setting                      2.设备编号库维护: Product No. setting  
 3.测试人员维护: Test staff setting        4.数据管理: Data Control

### 6.9.1 时钟设置页面 Clock setting page





在6.5菜单中，选择“时钟设置”将进入时钟设置页面。

In 6.5 menu, select “clock setting” entry into the clock setting page



时钟设置: Time setting    时: hour    分: Minutes    秒:Seconds

按“”键选择，按“”“”键可以对时间进行修改，按“”键确认返回。

Press  button, the time can be modified by pressing“”“”.Press  to return.

### 6.9.2 数据管理页面 Data manage

在6.5菜单中，选择“数据管理”将进入数据管理页面。

In 6.5 menu, select “data manage” entry into the data management page.

## 6

### 页面说明



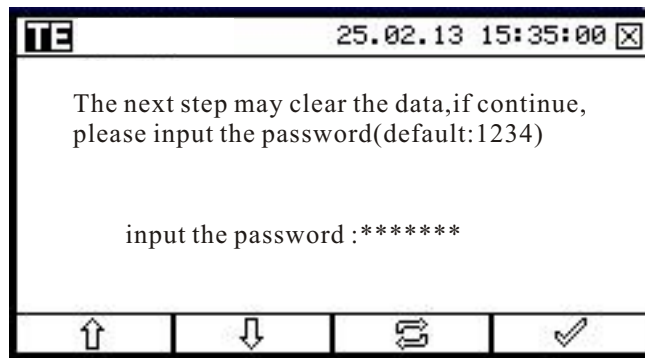
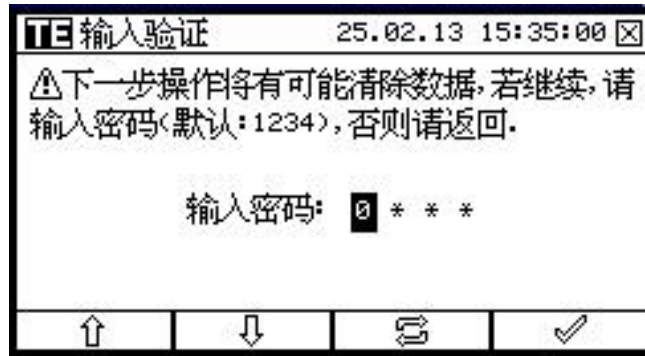

Page Instruction







## 6

### 页面说明

#### Page Instruction

首先要输入密码，出厂时默认为“1234”，按“”键选择，按“”“”键可以对时间进行修改，按“”键确认进入。

First, input the code, and the default code is “1234” Press  button, the time can be modified by pressing “” “”. Press  to return.

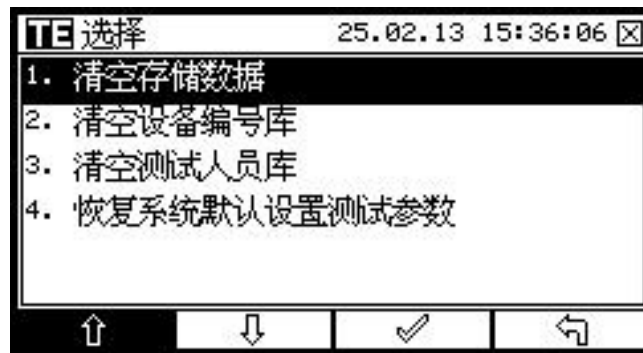

清空存储数据: Clear storage data 清空设备编号库: Clear product No.

清空测试人员库: Clear test staff

恢复系统默认设置测试参数: Recover system default settings test parameters

输入密码进入数据管理页面后，通过“↑”“↓”键选择，按“✓”确认，按“←”键返回上一级菜单。

After input the code, entry into the data manage page, press“↑”“↓”to select. Press“✓”to enter, press“←”to back to the previous menu.

## 6.10 帮助菜单页面 Help menu page

在主菜单页面，按“帮助”功能按键，仪器显示帮助页面：

In main menu page, press HELP button, the instrument will display the help page.



购买单位：Purchase Company      出场编号：Manufacturing No.

出厂时间：Produce Time      服务热线：Hotline

注意事项：Note      使用说明：Operation instruction      测试图例：Test graph

按“注意事项”功能按键，仪器进入注意事项页面；此页面主要显示仪器在安全操作方面的相关注意事项。用户在使用仪器前，请先阅读此页面内容，并请严格按照要求操作。使用“↑”、“↓”功能按键翻阅内容，使用“←”功能按键返回“帮助”页面。

按“使用说明”功能按键，仪器进入使用说明页面；此页面主要显示仪器正常使用时的一些操作说明。用户在使用仪器过程中，对照使用说明进行操作。按“↓”、“↑”功能按键翻阅内容，使用“←”功能按键返回“帮助”页面。

按“测试图例”功能按键，仪器进入测试图例页面；此页面主要显示仪器使用时的一部份接线图。用户在使用仪器时，可参考测试图例进行接线。使用“↓”、“↑”功能按键翻阅内容，使用“←”菜单返回“帮助”页面。

按“←”功能按键，仪器返回6.2主菜单页面。

Press the "Note" function button, the instrument into the note pages; This page shows the main notes of the safe operation of equipment. Before using, please read the contents of this page carefully, and in strict accordance with requirements of operation. “↑”、“↓”button used to read the content, and “←” used to back to the HELP page.

Click " HELP " function button, the instrument into the instruction page; this page mainly display the operation instruction when equipment in normal use . The user should operate refer to the instruction. “↓”、“↑”button used to read the content, and “←” used to back to the HELP page.

Click "Test Legend" function button, the instrument into the test legend page; this page mainly display part of wiring diagram when the equipment used . The user should refer to test the legend for wiring when operation.

按 “ ” 功能按键，仪器返回6.2主菜单页面。

Click“ ← ”button to back the 6.2 main menu.

## 6

### 页面说明

#### Page Instruction



## 7.1 如何更换打印纸 How to replace the printing paper

本仪器选用前换纸型打印机，不需拆机就可换纸，使用十分方便。

Paper can be changed without dismantling the machine due to front paper-change printer adopted by this instrument, which is very convenient.

(1) 打开打印机前盖板。

(1) Open the front cover board of the printer.

(2) 用手捏紧打印机内的纸轴，将其取出。

(2) Pinch the shaft and take out it.

(3) 装上打印纸，请将打印纸的光面朝上，并用打印机光感头压住打印纸，盖上打印机前盖板即可。

(3) Input paper. Keep the shiny side up. Let the light perception head suppresses the printing paper, and close the printer front cover.

## 7.2 如何更换保险丝

### How to replace the fuse

在电源插座下方有一个保险丝盒，用平口起子将该保险丝盒往上拉即可更换保险丝。保险丝规格为5 A。

There is a power outlet in the bottom of the fuse box, you can pull up the fuse box by a flat screwdriver and replace it. Fuse is 5A.

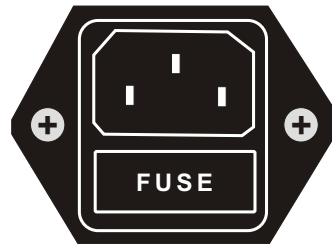

# 7

## 基本操作

### Basic Operation

## 8.1 接线准备 Preparation for Connection

(1) 将接地线一端夹在地网上，一端可靠的接于接地端子上。

(1) Clip one end of earth connection in the ground net and connect another end to the earth terminal reliably.

注意：地网的接地点应具有良好的导电性，否则会影响测量的正确性。

Notice: ground points of the ground net shall be of good conductivity. Otherwise, the accuracy of test shall be affected.

(2) 严格按四端子法接好测试线。

(2) Connect testing wires in accordance with the Four-terminal Method strictly.

(3) 测量开关时，应将开关处于闭合状态。

(3) Close the switch when measure the switch.

注意：闭合开关后，应重新夹紧测试钳及测试夹，以免振动时，造成测试钳及测试夹与试品之间的松动，从而形成接触不良好的现象。

Notice: after close of switch, re-clamp the test fixture and test clip in order to prevent loosening of test tools and bad connection.

(5) 插上电源插头。

(5) Plug in the power socket.

## 8.2 测试步骤 Test steps

(1) 合上电源开关，仪器显示开机页面。

(1) Close the power switch so that the instrument will display the start page.

(2) 按“测试”功能按键,进入测试页面。

(2) Directly press “Enter” in the “Test” menu after log on so that the instrument will enter the test page.

(3) 更改所需要的电流和时间。

(3) Change current and time as required.

(4) 选择“开始测试”菜单，按确认键进行测试。

(4) Select “Start Test” menu and press “Enter” for the test.

(5) 测试完毕，进入“数据存贮”页面，对数据进行打印或存贮，方便以后查看。

---

(5) When the test is finished, enter the “data storage” page for print or storage for the convenience of future check.

注意：电源未关闭前请勿移动测试夹，以免大电流输出导致打火，可能损坏试品及危害人生安全。

Note: Do not move the test folder before the power is off, so as not to cause ignition high current output, which may endanger life safety and cause damage to the test product.

### 8.3 试验结束后现场清理 Field Clearance after the Test

- (1) 关掉电源开关，拔下电源线。
- (1) Close off the power switch and pull out the power line.
- (2) 将两组专用测试线拆除并收好，方便下次使用。
- (2) Dismantle two groups of special testing wires and pack away for the convenience of use next time.
- (3) 拆除接地线，并整理好。
- (3) Dismantle earth connections and put them into rights.

## 9.1 运输 Transportation

本产品运输时必须进行包装，包装箱可用纸箱或木箱，包装箱内应垫有泡沫防震层。包装好的产品，应能经公路、铁路、航空运输。运输过程中不得置于露天车箱。仓库应注意防雨、防尘、防机械损伤。

This product must be packaged for transportation, packing box can be carton or wooden case, the box should underlay shock-proof layer such as foam, etc. Well Packaged products should be able to transport by road, rail, and air. The products should not be placed in open trunk during transportation, and warehouse should keep away from rain, dust, mechanical damage.

## 9.2 储存 Storage

仪器平时不用时，应储存在环境温度 $-20^{\circ}\text{C} \sim 60^{\circ}\text{C}$ ，相对湿度不超过85%，通风，无腐蚀性气体的室内。存储时不应紧靠地面和墙壁。

Equipment should be stored indoors at ambient temperature  $-20^{\circ}\text{C} \sim 60^{\circ}\text{C}$ , relative humidity no more than 85%, ventilation, no corrosive gases. Equipments Should not be placed close to the ground and walls.

# 9

## 运输与保养

### Transportation & Maintenance

## 9.3 防潮 Damp Proof

在气候潮湿的地区或潮湿的季节，本仪器如长期不用，要求每月开机通电一次（约二小时），以使潮气散发，保护元器件。

In humid areas or damp season, if the equipment seldom use, it must be powered on once a month (about two hours), in order to disperse moisture, and protect electronic components.

## 9.4 防曝晒 Anti-exposure

仪器在室外使用时，尽可能避免或减少阳光对液晶显示屏的直接曝晒。

When the equipment used outdoors, please keep the equipment far away from sun, and avoid direct sun exposure on the LCD screen.

|      |                                  |            |
|------|----------------------------------|------------|
| 10.1 | 220V电源线                          | 一根         |
|      | 220V Power line                  | 1 piece    |
| 10.2 | 专用测试线                            | 两组         |
|      | Special test line                | two pieces |
| 10.3 | 使用说明书                            | 一份         |
|      | User manual                      | 1 piece    |
| 10.4 | 产品合格证                            | 一张         |
|      | Product certificate              | 1piece     |
| 10.5 | 产品出厂检验报告                         | 一份         |
|      | Delivery inspection report       | 1piece     |
| 10.6 | 打印纸                              | 一卷         |
|      | Print paper                      | 1 roll     |
| 10.7 | 保险丝 (5 A)                        | 四个         |
|      | Fuse                             | 4 pieces   |
| 10.8 | 双色接地线 (6米)                       | 一根         |
|      | Double-color grounding line (6m) | 1piece     |
| 10.9 | 机箱钥匙                             | 两把         |
|      | Chassis Key                      | 2 pieces   |

**10**

## 随机附件

Accessories

## 质量保证与售后服务

### Quality Assurance and After-sales Service

(1) 本仪器严格按照国家标准和企业标准制造，每一台仪器都经过严格的出厂检验。

(1) The manufacturer of this equipment is in strict accordance with national standards and enterprise standards, the production procedures are strictly enforce the ISO9000 standards to ensure quality of the equipment.

(2) 本仪器享有24个月的保用期，在此期间由于制造上的原因而使质量低于特性要求的本公司将免费予以保修。

(2)The warranty of this instrument is 24 months, during this period, we will offer free repair if the technical fault cause by manufacturing.

(3) 本仪器实行三包。

(3) The instrument enjoys the warranty of repair and maintenance.

(4) 在仪器使用寿命内，本公司将长期提供仪器的维护、使用培训、软件升级、配件供应等相关服务。

(4) We will offer long-term of maintenance, software upgrades, and accessories supply service, etc. within the service life of equipment.

(5) 如果在使用中发现问题，请及时与本公司联系，我们将根据情况采取：上门维修指导，或送回或寄回公司维修，或先发备用机给用户使用，后再寄回修理。

(5)Any questions during using, please contact with us, and send the equipment back to our company for repairing.

**11**

售后服务

After-sales service