

**Grid emulators** are specially designed to emulate grid disturbances. All range of grid emulators has different programmable parameters that allow flexibility to evaluate different kind of scenarios. They can generate different type of grids and its common faults and disturbances. Grid emulators can be used to study Distributed Energy Resources (DER). In these scenarios, the equipment can vary the capabilities of deliver, consume or store energy from or to the grid.

7.5 kVA – 200 kVA

4 Quadrant Power Amplifier

Grid disturbances emulation

AC: 0-480 Vrms  
10-230Arms

40-400Hz

DC: -750 V to 750 V

10-230A

### Functional description

It can generate different types of grids:

- o Three phase power grid (3F+N) from 0 to 480Vac
- o Power grid with variable frequency from 40 to 400Hz
- o DC Voltage Source from -750 to 750Vdc (optional)

Usual faults that can be generated:

- o Power grid with voltage harmonics control up to 15<sup>th</sup> (50-60Hz)
- o Flicker (programmable amplitude and frequency) and overvoltage
- o Generation of interruptions and voltage dips (types A, B, C, D)
- o Three phase power grids with programmable variations in frequency
- o Impedance of grid variable

Designed to be easy to use and cost effective in applications that require reliability for reproducing complex scenarios.

Programmable arbitrary profile via csv file.

1<sup>st</sup>-15<sup>th</sup> Harmonic, Flicker, voltage SAGs, variable output impedance

### Back-to-Back topology

Each cabinet integrates VSC modules and DSP control boards equipped with all necessary power components, electrical protections, auxiliary electronics and security elements.

The power electronics unit of each emulator is a back to back topology formed by 2 voltage source converters connected in series. It is a multifunctional AC-AC converter that shows a wide range of applications.

Some of the **applications**:

- o Test of electric and electronic equipment against electrical disturbances
- o PCC: point of common coupling
- o Test of control algorithms for electrical microgrid
- o Testing of electronic equipment under special conditions: 60 Hz, 400 Hz; 110 Vrms , 127 Vrms
- o Aircraft grid tests & disturbances
- o DC voltage source: photovoltaic panels, batteries...



# GE – Grid Emulator

## Conceptual Schematic

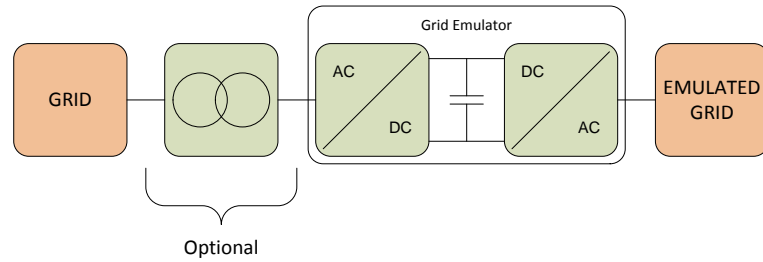

## Technical Diagram of GE

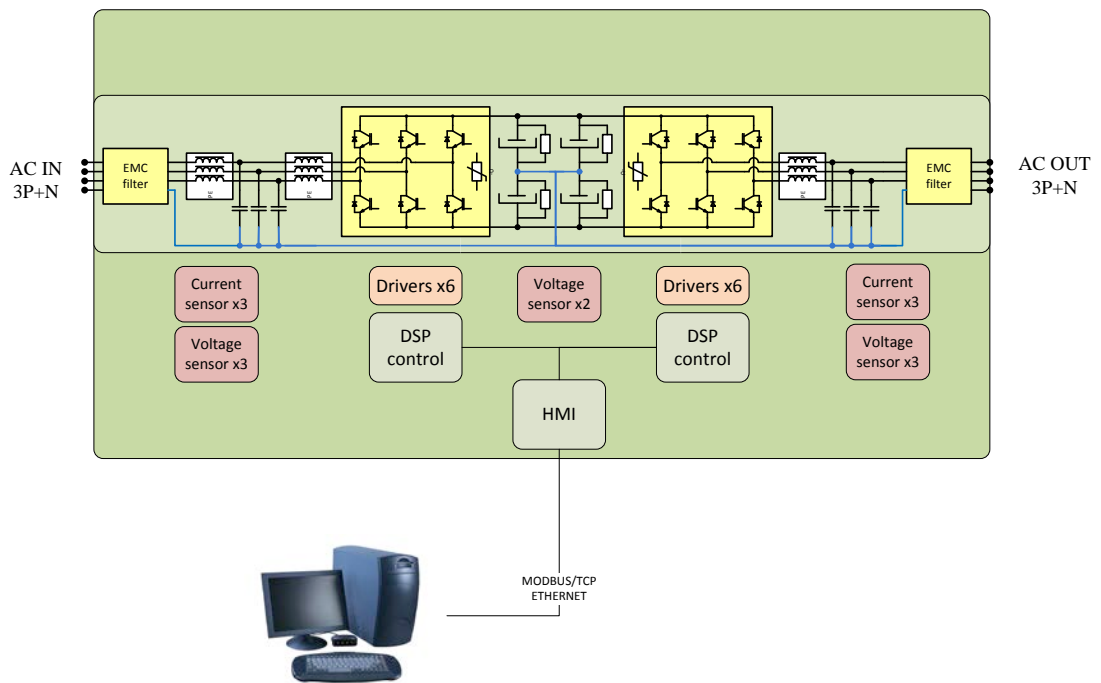

## Functionalities

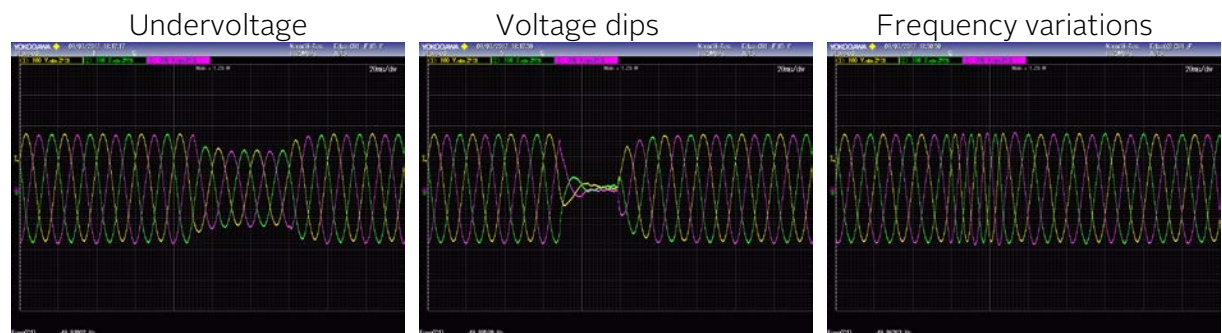

# GE – Grid Emulator

Aeronautics Grid

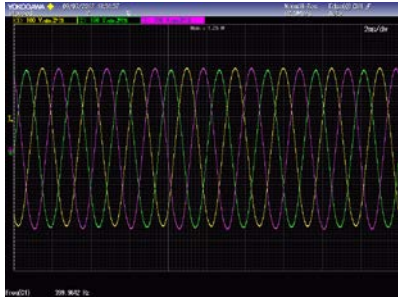

Voltage Harmonics



Flicker with application ramp

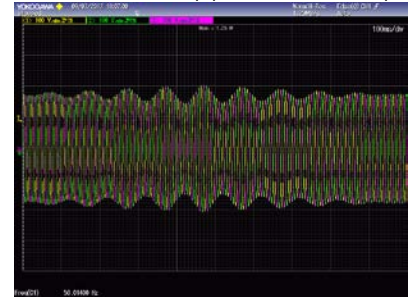

Unbalanced phases – Voltage Sags

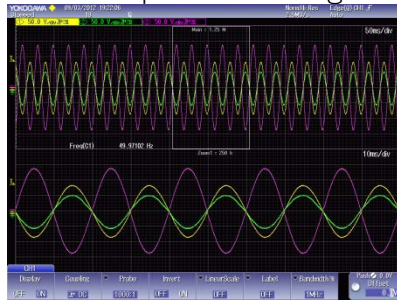

DC power supply with faults

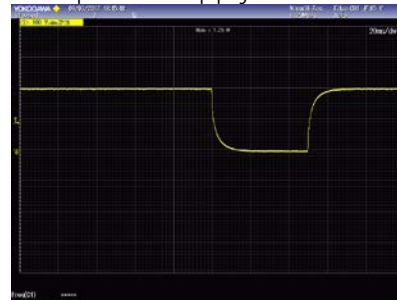

Consumption waveform at 200 kW @ 20 kHz

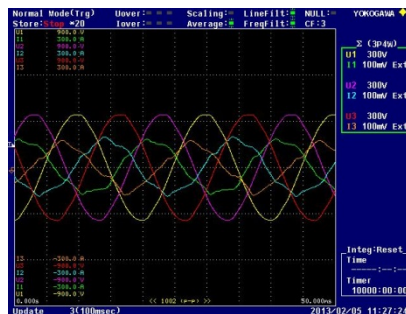

## User interface

Local 3.2" Touchscreen

Control port:

- 3 analog inputs +/-10V
- 3 analog outputs 0-10V
- 5 digital inputs
- 3 relay outputs
- 1 Emergency stop

*Note: all inputs/outputs are isolated*

Remote interface: Modbus/TCP

Windows 7/XP application for remote operation and data acquisition.

# GE – Grid Emulator

---

## Cooling

The power supply is air-cooled internally.

---

## Mechanical housing

The power supplies are housed in compact mechanical cabinets with wheels (up to 120kVA) for easier transportation.

---

## Options

IEC61850

RS485

DC Voltage Source

---

# GE – Grid Emulator

## Range and specifications

Magnitude		Value		
Power		7.5kVA-200kVA		
Input side				
AC Voltage	Rated	3x400V+Neutral+Earth		
Voltage range		+15% / -20 %		
AC Current		10A-290Arms		
Frequency		50/60Hz		
Power Factor	Controllable	-1/1 (capacitive/inductive)		
Efficiency	At full load	>92%		
Overload		125% for 10 min / 150% for 60 s		
Output side				
AC Voltage	Phase-phase	0-480Vrms		
AC Current	Single-phase	10-230Arms		
Frequency		40-400Hz		
Harmonic content	Per phase	1 <sup>st</sup> – 15 <sup>th</sup> at 50Hz, 1 <sup>st</sup> – 13 <sup>th</sup> at 60Hz (only 1 <sup>st</sup> harmonic for 400Hz)		
DC Current	(Optional)	10-230Arms		
DC Voltage	(Optional)	±750V		
Modes of operation		Range	Resolution	Ripple
Constant Voltage		0-100%	<±0.1%	<1%
Faults Generation		Voltage dip		
		Over and Undervoltage		
		Frequency variation		
		Flicker		
		Harmonic sequence		
GENERAL				
Measurements	Input Voltage (Vrms) and Current (Irms)			
	Input Power			
	Output Voltage and Current			
	Output Power			
	Temperatures			
User interface	3.2" Touchscreen			
	Control port: 3 analog inputs, 3 analog outputs, 5 inputs, 3 relay outputs			
	Communication Ports: Ethernet, RS485 (optional)			
	Communication Protocols: Modbus/TCP			
	Customized communications for IEC61850, ERP or MATLAB® (optional)			
Humidity	10-90% (Absolute maximum, without condensation)			
Temperature	5-40°C (Absolute maximum)			
Refrigeration	Forced air			
Protections	Over Current, Over Voltage, Shortcircuit, Overtemperature			
Standards				
Safety	EN-62040-1-2, EN-60950-1			
EMC	EMC: EN-62040-2			

# GE – Grid Emulator

## GE models

Reference	Rated Power		Rated Current		Rated Voltage	Dimensions
	kVA	kW	AC rms	DC (per channel)	DC (per channel)	DxWxH
GE7.5	7.5	6.75	10A	10A	±750V	700x450x1100
GE10	10	9	15A	15A	±750V	700x450x1100
GE15	15	13.5	20A	20A	±750V	700x450x1100
GE20	20	18	30A	25A	±750V	700x450x1100
GE30	30	27	40A	40A	±750V	805x590x1320
GE40	40	36	55A	50A	±750V	805x590x1320
GE50	50	45	70A	65A	±750V	805x590x1320
GE60	60	54	85A	80A	±750V	805x590x1320
GE80	80	72	115A	105A	±750V	805x590x1320
GE100	100	90	145A	130A	±750V	805x590x1320
GE120	120	108	175A	155A	±750V	805x590x1320
GE160	160	128	230A	185A	±750V	850x900x2000
GE200	200	160	290A	230A	±750V	850x900x2000



C/ IKEA, 51 - LOCAL B - 48940 LEIOA - VIZCAYA

TFNO.: 944803040 - FAX: 944348191

Email: [isotest@isotest.es](mailto:isotest@isotest.es)

<http://www.isotest.es>