

# Sorensen SG Series



4–150 kW

## Programmable Precision High Power DC Power Supply

10–800 V

- High Power Density: up to 15 kW in 3U, 30 kW in a 6U chassis
- Wide Voltage Range: 0-10V up to 0-800V, in increments of 5 kW from 5 to 30 kW
- Fast Load Transient Response: Protection from undesired voltage excursions
- Low Ripple and Noise
- Hardware Trigger (Ethernet Option)
- Paralleable up to 150 kW
- Sequencing: Free system controller & speed up test
- Low audible noise: Temperature controlled variable speed fans



6–6000 A



208

400

480

ETHERNET



LXI

RS232

The Sorensen SG series (hereafter SG Series) represents the next generation of high power programmable DC power supplies. The SG Series is designed for exceptional load transient response, low noise and the highest power density in the industry. With a full 15 kW available down to 20VDC output in a 3u package the SG leads the industry in power density. The power density is enhanced by a stylish front air intake allowing supplies to be stacked without any required clearance between units.

At the heart of the SG series is a 5 kW power module. Depending on the output voltage, one to six modules can be configured in a single chassis to deliver 5 kW to 30 kW of power. Combinations of these chassis can then be easily paralleled to achieve power levels up to 150 kW. Paralleled units operate like one single supply providing total system current. Available in two control versions, the SGA has basic analog controls, while the SGI provides intelligent control features

### SGI: Advanced Intelligent Control

(Sorensen General purpose Intelligent) The SGI combines onboard intelligent controls with the outstanding power electronics common to all SG family supplies. These controls enable sophisticated sequencing, constant power mode and save/recall of instrument settings. Looping of sequences makes the SGI ideal for repetitive testing. An impressive vacuum fluorescent graphical display in eight languages, context sensitive “soft” keys and front panel keyboard simplify programming of the SGI.

### SGA: Outstanding Value - Analog Control

(Sorensen General purpose Analog) The SGA, with its industry leading price performance, is available for customers requiring simple front panel analog controls or external control. With the same high performance power electronics as the SGI, the SGA provides essential features like 10- turn potentiometers for setting voltage and current, 3 ½ digit LED readout plus front panel over-voltage protection (OVP) preview/adjustment and reset.

**AMETEK**  
**Programmable Power**  
 9250 Brown Deer Road  
 San Diego, CA 92121-2267  
 USA



# SG Series : Product Specifications

Common					
Remote Sense	Terminals are provided to sense output voltage at point of load. Maximum line drop 5% of rated voltage per line for 40-100V models, line drop 1V of rated voltage per line for 10-20V models, 1.5V for 30V models, 2% of rated voltage per line for models 160V and greater. (Greater line drop is allowed, but output regulation specifications no longer apply).				
Parallel Operation	Up to 5 units may be paralleled for additional current within the power supply single-unit specifications, with exception of the DC output current set accuracy. Additional paralleled SG units will add 0.3% inaccuracy per unit. To parallel more than 5 units, contact factory.				
Series Operation	Up to 2 units (see Output Float Voltage)				
Input					
Nominal Voltage 3 phase, 3 wire + ground	208/220 VAC (operating range 187 - 242 VAC) 380/400 VAC (operating range 342 - 440 VAC) 440/480 VAC (operating range 396 - 528 VAC) 30V and below passive pfc for 0.9 typical, at full load, all input voltages.				
Frequency	47 – 63Hz , 400Hz ( 400Hz @ 208VAC, for 6U units is optional modification and does not carry CE, UL or CSA markings )				
Power Factor	>0.9 typical for 208/220 VAC input (10V - 800V) >0.78 typical for 380/400 VAC input (40V - 800V) >0.9 typical for 380/480 VAC input (10V - 30V) >0.7 typical for 440/480 VAC input (40V - 800V) >0.9 typical for 440/480 VAC input (10V - 30V)				
Protection ( typical )	½ cycle ride-through on all three phases, 3 cycle ride through on single phase; missing phase shutdown ( 800V model 6.4 msec on all 3 phases )				
Programming & Read-back Specifications ( with sense wires used )					
	Programming		Read-Back / Monitoring		
	Accuracy	Resolution	Accuracy	Resolution	
Front panel Display	SGA: +/- (0.5%fs + 1 digit) SGI (40-800V) +/- 0.1% of voltage at full scale SGI (40-800V) +/- 0.4% of current at full scale  SGI (10-30V) 0.1% of set point +0.1% of voltage rating SGI (10-30V) 0.1% of set point +0.4% of current rating	SGA: 3.5 digits SGI: 4.0 digits	SGA: +/- (0.5%fs + 1 digit) SGI, Voltage: +/- 0.1% of full scale SGI, Current: +/- 0.4% of full scale  SGI (10-30V) 0.1% of actual +0.15% voltage rating	SGA: 3.5 digits SGI: 4.0 digits	Knob control & Display read-back
Remote Analog Interface	Voltage +/-0.25% of full scale Current (40-800V) 0.8% of full scale , (10-30V) 1.0% of full scale	NA	(40-800V) +/-1.0% of full scale  (10-30V) +/-0.5% of full scale	NA	25-pin D-sub connector (0~5 V or 0~10 V)
Remote Digital Interface	Voltage: +/- 0.1% of full scale, Current: +/- 0.4% of full scale	+/-0.002% of full scale	Voltage: +/- 0.1% of full scale Current: +/- 0.4% of full scale	+/-0.002% of full scale	RS-232C (Standard on SGI), Optional IEEE-488.2 and Optional LXI Compliant 10/100 base-T Ethernet (see Options)
OVP	+/- 1% of full scale	+/-0.002% of full scale			Programming range: 5-110% Configured from front panel, remote analog or via optional digital inputs
User I/O	Disconnect & Polarity-reversal relay control ( Only available with Ethernet Option )				Digital 10-pin Molex type connector See <a href="http://www.programmablepower.com">www.programmablepower.com</a>
Software	IVI & CVI drivers available under SUPPORT at: <a href="http://www.ProgrammablePower.com">www.ProgrammablePower.com</a>				
Physical	3U Models (10V-30V)		3U Models (40V-800V)		6U Models (40V-600V)
Width	19.00 in (48.3 cm)		19.00 in (48.3 cm)		19.00 in (48.3 cm)
Depth	25.65 in (65.15 cm)		25.46 in (64.7 cm)		27.06 in (68.8 cm)
Height	5.25 in (13.3 cm)		5.25 in (13.3 cm)		10.5 in (26.7 cm)
Weight	(4kW, 10V 15V) ≈<65 lbs (29 kg) (5kW, 20V 30V) ≈<65 lbs (29 kg) (8kW, 10V 15V) ≈<85 lbs (39 kg) (10kW, 20V 30V) ≈<85 lbs (39 kg) (12kW, 10V 15V) ≈<110 lbs (50 kg) (15kW, 20V 30V) ≈<110 lbs (50 kg)		(5kW) ≈ 40 lbs (18 kg) (10kW) ≈ 60 lbs (27 kg) (15kW) ≈ 80 lbs (36 kg)		(20kW) ≈ 120 lbs (54 kg) (25kW) ≈ 140 lbs (64 kg) (30kW) ≈ 160 lbs (73 kg)
Shipping Weight	Contact factory for more product & shipping weights				

# SG Series : Product Specifications

# 4-150 kW

Output			
Ripple & Noise (Voltage Mode, Typical)	See Output: Voltage & Current Ranges Chart below. Ripple and noise specified at full load, nominal AC input. Noise measured with 6 ft. cable, 1µf at load		
Ripple (Current Mode)	<+/- 0.04% of full scale rms current		
DC Voltage Slew Rate (40-800V)	≈< 100 ms 5-95% of full scale typical - resistive load (Contact factory for model specific slew rates)		
Output Voltage Rise Time (10-30V)	Rise Time, ms, max	Condition	
	10	Measured from 10% to 90% of the output voltage change - resistive load, typical	
Output Voltage Fall Time (10-30V)	Fall Time, ms max	Condition	
	No Load 1	100% CC Load	100% CR Load
	50	10	10
Output Current Rise Time (10-30V)	Rise Time, ms max	Condition	
	20	Measured from 10% to 90% of the output current change - resistive load, typical	
Output Current Fall Time (10-30V)	Fall Time, ms max	Condition	
	10	Measured from 90% to 10% of the output current change - resistive load, typical	
DC Current Slew Rate	45A / ms typical - resistive load		
Line Regulation ( with sense wires used )	(±10% of nominal AC input, constant load) Voltage Mode: +/- 0.01% of full scale (40-800V) Current Mode: +/- 0.05% of full scale (40-800V) Voltage Mode and Current Mode: +/- 0.05% of full scale (10-30V)		
Load Regulation (with sense wires used)	(no load to full load, nominal AC input) Voltage Mode: +/- 0.02% of full scale (40-800V) Current Mode: +/- 0.1% of full scale Voltage Mode: +/- 0.05% of full scale (10-30V)		
Load Transient Response	Recovers within 1ms to +/-0.75% of full-scale of steadystate output for a 50% to 100% or 100% to 50% load change		
Efficiency	87% typical at nominal line and max load		
Stability	±0.05% of set point after 30 minute warm-up and over 8 hours at fixed line, load and temperature, typical		
Temperature Coefficient	0.02%/ C of maximum output voltage rating for voltage set point, typical 0.03%/ C of maximum output current rating for current set point, typical		
Output Float Voltage	Negative terminal within +/- 300 V of chassis potential. ( We recommend the use of optional isolated analog Interface (IAI). ) Supplies in "series" should be the same output voltage/current, in not system current is limited to lower of the two supplies.		

Output: Voltage and Current Ranges								
Power	3U			6U			Ripple & Noise	
	4/5 kW	8/10 kW	12/15 kW	16/20 kW	20/25 kW	24/30 kW	rms (20 Hz-300 kHz)	p-p (20 Hz-20 MHz)
Voltage	Current							
10	400	800	1200	1600*	2000*	2400*	20 mV	50 mV
15	267	534	801	1068*	1335*	1602*	20 mV	50 mV
20	250	500	750	1000*	1250*	1500*	20 mV	60 mV
30	167	334	501	668*	835*	1002*	20 mV	60 mV
40	125	250	375	500*	625*	750*	20 mV	75 mV
60	83	167	250	333	417	500	20 mV	75 mV
80	63	125	188	250	313	375	20 mV	100 mV
100	50	100	150	200	250	300	20 mV	100 mV
160	31	63	94	125	156	188	25 mV	150 mV
200	25	50	75	100	125	150	25 mV	175 mV
250	20	40	60	80	100	120	30 mV	200 mV
330	15	30	45	61	76	91	30 mV	200 mV
400	12	25	38	50	63	75	40 mV	300 mV
600	8	17	25	33	42	50	60 mV	350 mV
800	6.2	12.5	18.7	25*	31.2*	37.5*	80 mV	500 mV

\* By way of paralleling 3U supplies

# SG Series : Product Diagram

## 3U Case (40-800V)

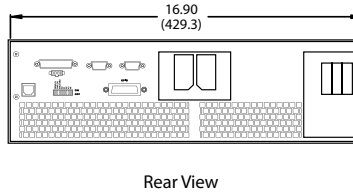
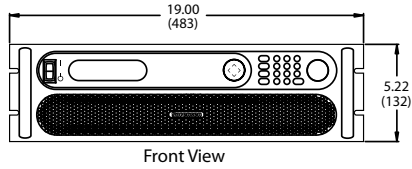
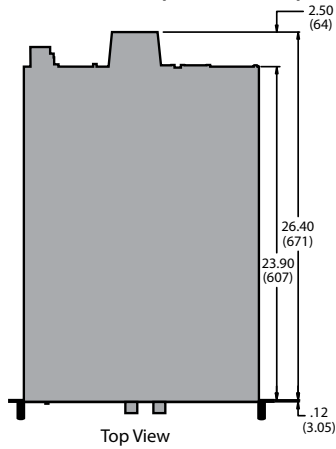

## 6U Case (60-600V)

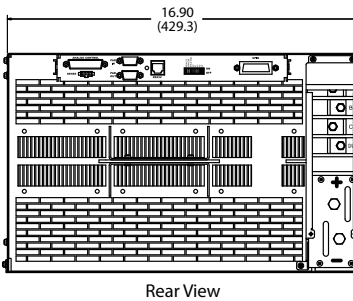
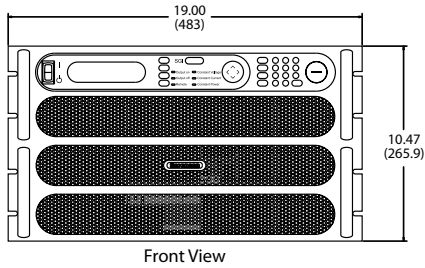
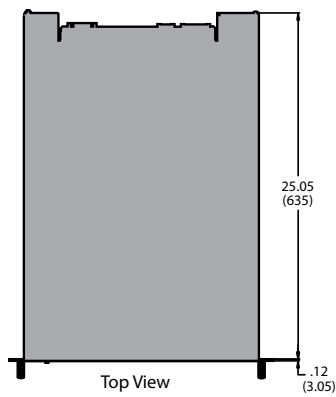

## 3U Case (10-30V)

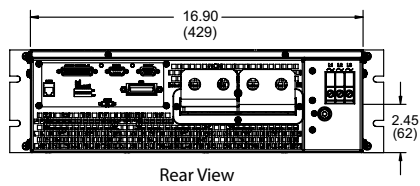
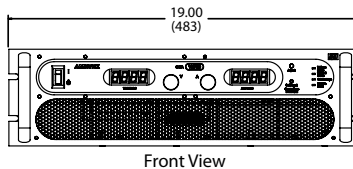
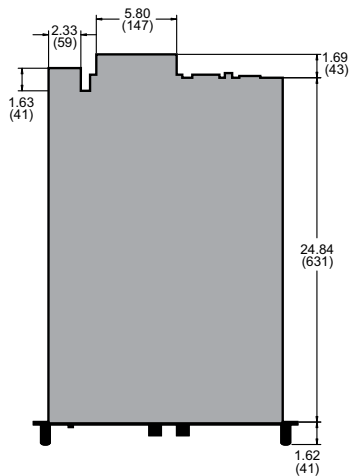

Dimensions in inches (millimeters)

## Advanced Power Simulation

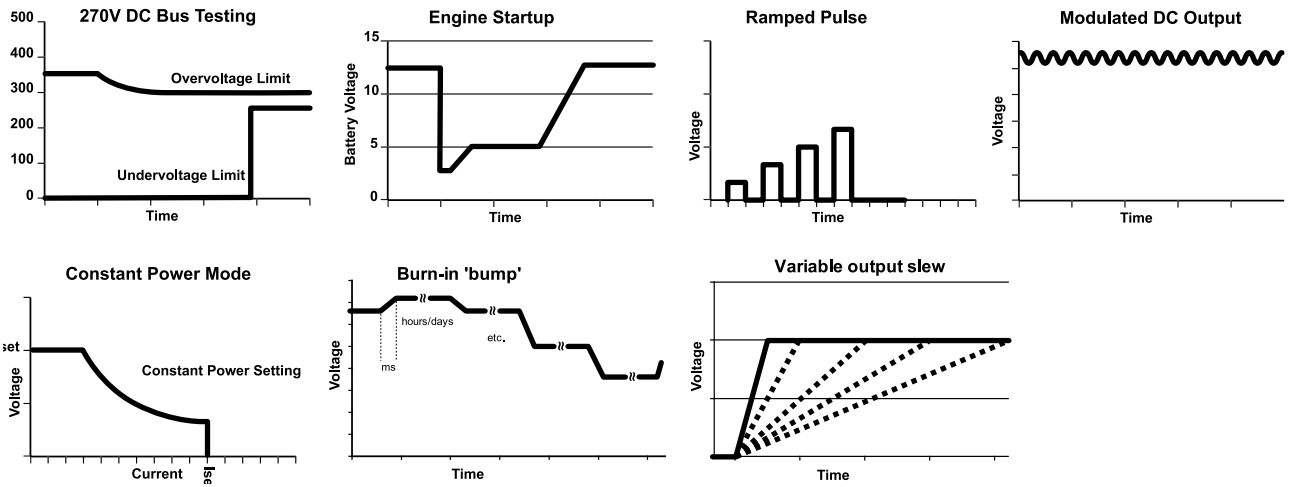

SGI model provides constant power mode allowing independent setting of the max voltage, current and power

## SGI / SGA Comparison Chart

Feature	SGA	SGI
Modular Design	•	•
Fast Load Transient	•	•
Parallelable	•	•
Analog & Digital Summing	Optional	•
Direct Front Panel V/I Control	•	•
3½ Digit LED Readout	•	
Graphics Display		•
Sequencing		•
Save/Recall Setups		•
System Power Readouts		•
Constant Power Mode		•
IEEE-488.2/RS-232C	Optional	RS-232C Std, IEEE-488.2 Optional
LXI Class C Ethernet/ RS-232	Optional	RS-232C Std, Ethernet Optional
Front Panel Dust Filter	Optional (3U unit only)	Optional (3U unit only)

## Environmental

Operating Temperature	0 to 50° C
Storage Temperature	-25° C to 65° C
Humidity Range	Relative humidity up to 95% non-condensing, 0° C – 50° C
Altitude	Operating full power available up to 5,000 ft. (~1,500 m), derate 10% of full power for every 1,000 feet higher; non-operating to 40,000 ft. (~12,000 m)
Cooling	Front and side air inlet, rear exhaust. Temperature controlled, variable speed fans. Units may be stacked without spacing.
Regulatory	Certified to UL/CSA 61010 and IEC/EN 61010-1 by a NRTL, CE Compliant, Semi-F47 Compliant. LVD Categories: Installation Category II: Pollution Degree 2; Class II Equipment: for Indoor Use Only. EMC Directive, EN 61326:1998
Front Panel Dust Filter	30 PPI (Pores Per Inch) - must ensure adequate airflow and / or derate max. temperature. 3U unit only.

# SG Series

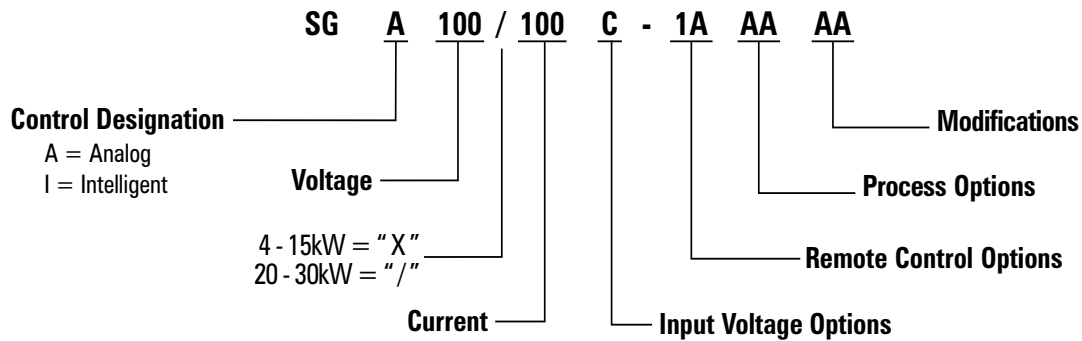

(For units up to 999A, Current is represented in numeric format (rounded to whole Amp), e.g., above "100" represents 100A. For units at 1000A and above, the current is represented by the format "XKX", e.g, 1K2 represents 1200A)

## Options and Accessories

Control Options	A: Analog I: Intelligent
Input Options	C: Input Voltage 187 / 242VAC, 3 Phase D: Input Voltage 342 / 440VAC, 3 Phase E: Input Voltage 396 / 528VAC, 3 Phase
Remote Control Options	0A: No Option 1A: IEEE-488.2 + RS-232C (Note: SGI comes standard with RS-232C) 1C: Ethernet + RS-232C 1D: Isolated Analog Control 1E: Shaft Locks (SGA series only)
Process Options	AA: No option AB: Certificate of Calibration (includes Test Data)
Modifications	AJ: Front panel dust filter - factory installed - 3U unit only CV: 400Hz AC input @ 208 VAC ( does not carry CE, CSA or UL marks ) ( 6U only ) STD on 3U
Accessories	890-453-03: Paralleling Cable (for up to 5 units, requires one cable per unit placed in parallel) K550212-01: 3U Rack Slides (for 5kW, 10kW and 15kW models) K550213-01: 6U Rack Slides (for 20kW, 25kW and 30kW models) 5550568-01: Front panel dust filter - field installation kit - 3U unit only 9550589-01: AC input cover - 3U unit only
Contact factory for other combinations	



C/ IKEA, 51 - LOCAL B - 48940 LEIOA - VIZCAYA

TFNO.: 944803040 - FAX: 944348191

Email: isotest@isotest.es

<http://www.isotest.es>

© 2011 AMETEK Programmable Power All rights reserved. AMETEK Programmable Power is the trademark of AMETEK Inc., registered in the U.S. and other countries. Elgar, Sorensen, California Instruments, and Power Ten are trademarks of AMETEK Inc., registered in the U.S.