



Rigel Medical
Bracken Hill
South West Industrial Estate
Peterlee
County Durham
SR8 2SW
England

Web site: www.rigelmedical.com
General Sales: +44 (0)191 587 8730
+44 (0)191 587 8745

Fax: +44 (0)191 586 0227
E-mail: sales@rigelmedical.com

Rigel Medical is part of the Seaward Group



SOLUTIONS FOR ELECTRICAL MEDICAL SAFETY

A PRACTICAL GUIDE TO IEC60601-1

YOUR GUIDE TO ELECTRICAL SAFETY TESTING

John Backes | Rigel Medical | August 2006 - 2nd Edition

©Copyright 2006 - All rights reserved. No part of this publication may be reproduced, stored in a retrieval system or transmitted in any form or by any means, electronic, mechanical, photocopying, recording, scanning or otherwise without prior written consent from SEAWARD GROUP.

"looking after your medical testing requirements"

www.rigelmedical.com



ELECTRICAL SAFETY ANALYSER

RIGEL 277 **PLUS**

*A Microprocessor controlled,
multi purpose electrical safety tester with memory*



FEATURES

- Test to IEC 60601 / 61010 / VDE751 / MDADB9801 / AS/NZ3200
- Dedicated IEC 60601-5 IEC 61010 body model
- Single test routine for BF/CF applied parts
- Compact design, portable stand alone instrument with integral database software
- Required current source for 25A/10A/100mA Earthbound test
- Full graphics user interface
- Fully manual, semi automatic and fully automatic test models
- User controllable power up and power down
- UTS system - optimises times for test routines



SOLUTIONS FOR ELECTRICAL MEDICAL SAFETY

Rigel Medical Company profile

Established for over 25 years, Rigel Medical is a well-known name in the field of electrical medical safety testing, with Rigel instruments used throughout the world. The original foundations were built on providing biomedical engineers and medical device manufacturers with electrical safety analysers dating back to the 1970's.

More recently, Rigel Medical has expanded their product offering with a dedicated range of analysers and simulators to test the correct performance of medical electronic devices. Such analysers and simulators include: Defibrillator / Pacemaker analyser, Patient Simulators, NIBP and SPO2 analysers and pressure / vacuum meters.

Rigel Medical is part of the Seaward Group of companies.

Innovation and Development

Rigel Medical are committed to continuous product development and extending the Rigel product range to bring our customers the leading edge biomedical engineering test and simulation products. Our aim is to ensure that we provide the best quality test instrumentation to the marketplace, to help our customers meet their needs in the most accurate and efficient way and ensure patient safety.

Quality

Quality systems are in place at all levels of the Rigel Medical operation and our products are tested and manufactured in ISO 9001 compliant facilities. All products have been designed to meet environmental safety conditions and meet many of the International medical standards.

Rigel Medical products are sold worldwide through an international network of agents and distributors.

Rigel Medical's website

For an in-depth resource and up to date news on Rigel's products go to www.rigelmedical.com

- Product information
- Latest news
- Software downloads
- Instruction manuals
- E-newsletter
- Where to buy

Table of Contents

FOREWORD	5
1. INTRODUCTION TO IEC 601	5
LOCAL ADAPTATION	6
COMMONLY USED DEFINITIONS WITHIN IEC 60601	6
SYMBOLS AND MARKINGS	8
2. VISUAL INSPECTION	9
2. EARTH BOND TESTING	9
4. LEAKAGE MEASUREMENTS	10
IEC 601 BODY MODEL	12
SINGLE FAULT CONDITION	12
EARTH LEAKAGE TEST	13
ENCLOSURE LEAKAGE TEST	14
PATIENT LEAKAGE	15
PATIENT LEAKAGE – F-TYPE	16
PATIENT AUXILIARY CURRENT	17
5. RECORD KEEPING	18
6. CONCLUSION	18
ANNEX A - IEC 60601-1 TEST LIMITS	19
ANNEX B - IEC60601-1 BODY MODEL	19
ANNEX C - PATIENT ENVIRONMENT	20
ANNEX D - IEC 60601 TEST STANDARDS	21

Foreword

This booklet is written as a guideline for people involved in testing medical electrical equipment and cannot be considered to replace the IEC 60601 standard.

All reasonable care has been taken to ensure accuracy of the information. Reference figures and data have been taken from the latest versions of various standards, guidance notes and recognised 'best practices' to establish the recommended testing requirements,

Rigel Medical, their agents and distributors, accept no responsibility for any error or omissions within this booklet, or for any misinterpretations by the user. For clarification on any part of this booklet please contact Rigel Medical before operating any test instrument, under relevant legislation.

No part of this publication shall be deemed to form, or be part of any contract for training or equipment unless specifically referred to as an inclusion within such contract.

Rigel Medical assumes, that the readers of this booklet are electronic technical competent and therefore does not accept any liability arising from accidents or fatalities resulting directly or indirectly from the tests described in this booklet.

1. Introduction to IEC 60601

It can be assumed that not all people will understand the dangers associated with the exposure to electricity. It is this danger that has triggered several discussions relating to the safety of all members of the public.

Regulatory bodies world-wide have acknowledged the dangers of electricity by producing legislation, standards and/or guidelines to control the design of electrical appliances in order to prevent any hazard to the general public.

One environment where electric currents pose an acute threat is in the medical treatment and care of patients. Often, patients are physically connected to one or more electrical medical devices for a period of time. In these circumstances it is possible that patients are unaware of being exposed to electrical currents, especially if patients are treated under full or local anaesthetic. During invasive treatments, the human body's natural protection organ, the skin, no longer provides the basic insulation against electrical currents. It is during these treatments that electrical currents as low as 50mA can float through the human body and cause the heart to fibrillate or paralyse the respiratory system.

To govern the design of medical equipment, the International Electrotechnical Committee, the IEC has produced a standard to control all aspects of safety directly or indirectly relating to the handling, use or connection to, of medical equipment. This standard is referenced to as IEC 60601, or by many simply referred to as IEC 601.

The IEC60601 was first published in 1977 (then referred to as IEC 601) and handles the electrical safety of both mechanical and electrical issues and is constructed from 2 parts; IEC 60601-1 and IEC 60601-2, each build-up from a number of basic or collateral standards.

IEC 60601-1-X (X representing a specific standard number between 1-4) is the primary standard and has four (sub) standards directly relating to the safety of medical equipment.

IEC 60601-2-X (X representing a specific standard number between 1-50). This part of the standard is specific to various types of medical equipment and provides additional information to the four basic standards.

Annex D provides an overview of the IEC 60101-1-X and IEC 60601-2-X standards.

This booklet describes the electrical safety requirements for compliances with IEC 60601-1. Although a type test standard, most of these tests are used for regular testing or after service or repair of medical devices.

Local Adaptation

In many cases the IEC 60601 standard has been adapted into local standards for use in countries around the world. Some examples are EN 60601 (EC), UL2601-1 (USA), CSA C22.2 (Canada) and AS/NZ 3200-1 (Australia / New Zealand).

Clearly, safety testing at the design stage and at the end of the production line are vitally important, but what about when the equipment enters service? Pending a recognised international standard for in-service testing, a number of countries have introduced their own national test recommendations.

Some countries have gone one step further and produced standards or guidelines for safety testing of newly delivered medical devices (also referred to as acceptance test), testing during regular intervals, (also referred to as preventive maintenance), or directly following service or repair. Some examples are MDA DB9801 (UK), VDE 750/751 (Germany), AS/NZ 3551 (Australia / New Zealand), NFPA / AAMI (USA)

Countries without a national guidance or code of practice mainly follow the manufacturers instructions or guideline, which most likely refer to the IEC 60601-1 test requirements and limits to be repeated. In essence all standards have one thing in common and that is to control the safety of medical devices for use in the treatment, care and diagnosis of patients and/or individuals.

Commonly used definitions within IEC 60601

Equipment Under Test	The equipment (EUT) which is the subject of testing.
Device Under Test	The device (DUT) which is the subject of testing.
Applied Part	Part of the medical equipment, which is designed to come into physical contact with the patient, or parts that are likely to be brought into contact with the patient.
Patient Connection	Individual physical connections and / or metal parts intended for connection with the patient, which form (part of) an Applied Part.

Patient Environment	Volumetric area in which a patient can come into contact with medical equipment or contact can occur between other persons touching medical equipment and the patient, both intentional and unintentional. (see <i>Annex C</i>)
F-Type Applied Part	Applied Part which is electrically isolated from Earth and other parts of the medical equipment. i.e. floating. F-type applied parts are either type BF or type CF applied parts.
Type B Applied Part	Applied Part complying with specified requirements for protection against electric shock. Type B Applied Parts are those parts, which are usually Earth referenced. Type B are those parts not suitable for direct cardiac application.
Type BF Applied Part	F-Type Applied Part complying with a higher degree of protection against electric shock than Type B Applied Parts. Type BF Applied Parts are those parts not suitable for direct cardiac application.
Type CF Applied Part	F-Type Applied Part complying with the highest degree of protection against electric shock. Type CF Applied Parts are those parts suitable for direct cardiac application.
Medical Electrical Equipment	Electrical equipment, designed for treatment, monitoring or diagnoses of patients, powered from not more than one connection to mains supply and which are necessarily in physical or electrical contact with the patient or transfers energy to or from the patient or detects such energy transfer to or from the patient.
Medical Electrical System	Combination of equipment of which at least one is classed as medical electrical equipment and as such specified by the manufacturer to be connected by functional connection or use of a multiple portable socket-outlet.
Class I (Earthed)	Equipment protection against electric shock by additional protection to basic insulation through means of connecting exposed conductive parts to the protective earth in the fixed wiring of the installation.
Class II	Also referred to as Double Insulated. Equipment protection against electric shock by additional protection to basic insulation through means of supplementary insulation are provided, there being no provision for the connection of exposed metalwork of the equipment to a protective conductor and no reliance upon precautions to be taken in the fixed wiring of the installation.

NOTE

CLASS II EQUIPMENT may be provided with a FUNCTIONAL EARTH TERMINAL or a FUNCTIONAL EARTH CONDUCTOR.









Symbols and Markings

The IEC 60601 has defined the requirements for information / data to be present on the medical equipment's nameplate, in order to form an unambiguous identification of the equipment.

Information must include: manufacturers name, model number, serial number, electrical requirements etc.

The IEC 60601 standard refers to a large variety of symbols for use on medical equipment, medical systems, accessories and other related parts. A full overview of the symbols used in IEC 60601 is provided in the standard.

For the purpose of this booklet, a selection of the most commonly used symbols are displayed below:

	Class I		Earth Reference point
	Class II	CE	i.e. "Conformité Européenne"
	Type B Applied Part		Defibrillation proof type B Applied Part
	Type BF Applied Part		Defibrillation proof type BF Applied Part
	Type CF Applied Part		Defibrillation proof type CF Applied Part

2. Visual Inspection

The process of visual inspection is not clearly defined by IEC 60601, however visual inspections form a critical part of the general safety inspections during the functional life of medical equipment. Upto, 70% of all faults are detected during visual inspection.

Visual inspection is a relatively easy procedure to make sure that the medical equipment in use is still conform the specifications as released by the manufacturer and has not suffered from any external damage and or contamination.

These can include the following inspections:

- Housing / Enclosure; *Look for damage, cracks etc*
- Cabling (supply, applied parts etc); *Look for cuts, wrong connections etc*
- Fuse Rating; *Check correct values after replacement*
- Markings and Labelling; *Check the integrity*
- Integrity of Mechanical Parts; *Check for any obstructions*

3. Earthbond Testing

Earthbond Testing, also referred to as Groundbond Testing, tests the integrity of the low resistance connection between the earth conductor and any metal conductive parts, which may become live in case of a fault on Class I medical devices. Although many Class I medical devices are supplied with an earth reference point, most if not all medical devices require multiple earthbond tests to validate the connections of additional metal accessible parts on the enclosure.

The test current is applied between the earth pin of the mains supply plug and any accessible metal part (including earth reference point) via a dedicated earth bond test lead (clip/probe).

The IEC 60601-1 (clause 8.6.4) requires a minimum test current of 25 Ampere AC or 1.5 times the highest rated current of the relevant circuit(s) which ever is greater. The open circuit voltage of the current source should not exceed 6V.

A test current of 25 Ampere AC is most commonly used. Due to the exposure of high current, some (parts of the) equipment could be damaged and thus requiring a lower test current. However, the earthbond test is designed to stress the connection under fault conditions.

Faults in the detachable power cord account for 80-90% of all earthbond failures, as most moulded power cables are prone to stress when the cables are dropped.

For fixed installations (ie MRI or X-RAY equipment) a Point-to-Point continuity measurement can be made. The resistance is then measured between two probes, where one would be connected to the incoming earth reference point and one probe is placed on metal accessible parts of the medical installation.

Test limits are set at 0.1 Ohm for fixed power cords and 0.2 Ohm for equipment with a detachable power cord. See *Annex A* for a full overview of the IEC 60601-1 test limits.

Prolonged use of testing at high currents can lead to a high probe temperature. Care should be taken to avoid touching the probe tip under these conditions.

4. Leakage Measurements

Research has shown that current not voltage is often the source of injury or death. It takes only a small amount of current to cause major consequences.

When an electrical current flows through the human body the effect is influenced by two main factors, firstly the amount of current and secondly the length of time the current flows.

For example; the heart stops if the current persists for:

- a) 250mS at 40mA
- b) 100mS at 100mA
- c) 50mS at 200mA

Consider the following examples of the effect of current on the human body when applied to the skin (non invasive);

0.9	—1.2mA	Current just perceptible
15.0	—20.0mA	Release impossible: cannot be tolerated over 15 minutes
50.0	—100.0mA	Ventricular fibrillation, respiratory arrest, leading directly to death
100.0	—200.0mA	Serious burns and muscular contraction of such a degree that the thoracic muscles constrict the heart

Compare these values to the fact that 250mA of current is required to power a 25 watt lamp

For this reason, the IEC 60601 committee has set stringent rules on the design of medical equipment as to prevent any patient or operator being exposed to currents not part of the functional operation of the device. These currents are referred to as leakage currents.

IEC 60601-1 requires that leakage current measurements of medical devices are performed when the equipment is powered from an earth referenced supply (through isolation transformer), with an output voltage of 110% of the rated supply voltage. The medical device must be in full operational mode and at operational temperature if applicable. In many cases, isolation of medical devices is only provided by active circuitry; hence true leakage values can ONLY be measured once the equipment is in full operation. Equipment that is not in full operation might result in FALSE low leakage values.

IEC 60601 defines leakage current of three different sources.

- **Earth Leakage;** current flowing down the protective earth conductor of the mains inlet lead.
- **Enclosure Leakage;** current flowing to earth through a person by touching the medical equipment / system or part of.
- **Applied Part or Patient Leakage;** current flowing through a person to earth from the applied part or current flowing from a person to earth via the applied part by applying unintended voltage from an external source.

Applied Part / Patient Leakage can be classed into number of measurements such as:

- Patient Leakage (*please refer to the corresponding paragraph*)
- Patient Auxiliary Leakage (*please refer to the corresponding paragraph*)
- Patient F-type Leakage (*please refer to the corresponding paragraph*)

Applied Part or Patient Leakage is the most important part of the leakage measurement on any medical device. Applied Parts are directly in contact with the patient and are in case of invasive devices placed under the patient's skin, which forms our natural protection against electrical currents. Currents applied under the skin can result in far greater consequences. Currents as low as 15µA can result in fatality.

The limits for leakage currents within the IEC 60601-1 requirements are set to minimizing the probability of ventricular fibrillation to a factor as low as 0.002 (Limit of 10µA for CF Applied Part under normal condition). See *Annex A* for a full overview of the IEC 60601-1 test limits.

The following tests find their origin from the IEC 60601-1 but are specific the AAMI and NFPA 99 standards (USA)

- Patient Leakage - Applied Part to Ground.
Similar to Patient Leakage described above.
- Patient Leakage - Applied Part to Case.
Similar to Patient Leakage except that the leakage current path is from the applied parts, through the patient, to the case of the EUT/DUT.
- Patient Auxiliary (Applied Part to Applied Part);
Similar to Patient Auxiliary current.
- Patient Auxiliary (Applied Part to All); *Similar to Patient Auxiliary current.*

For the purpose of this booklet, the focus will be on the directly related leakage measurements as per IEC 60601-1.

WARNING - Mains voltage applied to appliance

It is important to verify that a medical device with moving parts (e.g. motor or pump) is safely mounted to allow movement without causing damage to equipment or personnel. Secondary earth paths will effect the leakage measurements and might give false PASS readings. Always make sure that the device under test is positioned safely and isolated from earth when measuring leakage.

IEC 601 Body Model

To ensure a traceable simulation of current as if passing through a human body, measurement circuits have been designed to simulate the average typical electrical characteristics of the human body. These measurement circuits are referred to as Body Models or Measuring Device (MD in IEC 60601-1)

Some standards such as the AAMI / NFPA 99 and the IEC 61010 (electrical equipment for measurement, control and Laboratory use) specify different electrical characteristics to that of the IEC 60601-1.

The IEC 60601-1 body model or measuring device is shown in *Annex B*.

Single Fault Condition

To maintain a medical device's high level of protection during its operational life, a number of design features are taken into account to maintain the integrity of the device's electrical safety. This is done by introducing conditions that could occur under normal use (ie reversed mains supply or voltage on signal input/output terminals - SIP/SOP) and conditions that can occur under a single fault condition (SFC).

IEC 60601-1 specifies a number of single fault conditions (SFC) under its clause 8.1. For the purpose of this booklet, the only highlighted SFC are the interrupted earth connection (Open Earth) and interruption of any of the supply conductors (Open Neutral).

IEC 60601-1 specifies that all leakage measurements should be carried out using normal and single fault conditions. A typical part of the electrical safety testing procedures is to perform the test as follows:

- | | |
|----------------------------|--------------|
| 1. Normal Supply Voltage | No (SFC) |
| 2. Normal Supply Voltage | Open Neutral |
| 3. Normal Supply Voltage | Open Earth |
| 4. Reversed Supply Voltage | No (SFC) |
| 5. Reversed Supply Voltage | Open Neutral |
| 6. Reversed Supply Voltage | Open Earth |

In addition to these test, some manufacturers might choose to include voltage on the signal input / output terminals (ie communication ports such as USB or RS 232). As this test can be destructive, it is not commonly used other than during type testing of the medical electrical equipment.

Enclosure Leakage Test

In general, Enclosure Leakage displays the current that would flow if a person would come in contact with the housing (or any accessible part not intended for treatment or care) of the medical device.

IEC 60601-1 specifies that the measurements are done under normal and reverse operation of the mains supply and single fault conditions Open Neutral circuit and Open Earth. The Enclosure Leakage Test is valid for both Class 1 and II equipment with Types B, BF and CF Applied Parts. *Annex A* shows the pass/fail limits as per IEC 60601-1 requirements.

Note - for Class II equipment, the Single Fault Earth Open tests are not required.

In the case of Class II devices, or fully insulated enclosures, this can be encapsulated by using aluminium foil of approximately 200 cm². The enclosure leakage is measured by connecting the aluminium foil to the leakage tester.

Diagram B shows a schematic interpretation of the earth leakage measurement including the relays operating the single fault conditions.

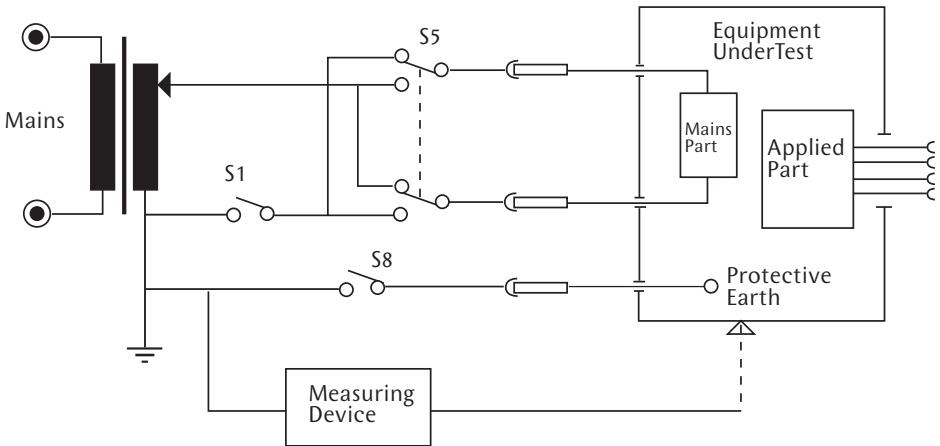

Diagram B - Test Circuit For Enclosure Leakage

Enclosure Leakage, normal condition - This test measures the enclosure leakage current under normal conditions. The current is measured through the Measuring Device with S1 and S8 closed and S5 normal and reversed.

Enclosure Leakage, single fault, supply open - This test measures the enclosure leakage current with a single fault condition (supply open). The current is measured through the Measuring Device with S1 open, S8 closed and S5 in normal and then S5 reversed.

Enclosure Leakage, single fault, earth open - This test measures the enclosure leakage current with a single fault condition (earth open). The current is measured through the Measuring Device with S1 closed, S8 open and S5 in normal and then S5 reversed.

Patient Leakage

The Patient Leakage Current is the current flowing from the Applied Part via the patient to earth or flowing from the patient via an Applied Part to earth, which originates from an unintended voltage appearing on an external source.

IEC 60601-1 specifies that the measurements be done under normal and reverse operation of the mains supply and single fault conditions Open Neutral circuit and Open Earth. The Patient Leakage Test is valid for both Class 1 and II equipment with Types B, BF and CF applied. Annex A shows the pass/fail limits as per IEC 60601-1 requirements.

Note For Class II equipment, the Single Fault Earth Open tests are not required.

For type CF equipment the patient leakage current is measured from each applied part separately however, for type B and BF equipment, the patient leakage current is measured with all applied parts connected together. **Diagram C** shows a schematic interpretation of the Patient Leakage measurement including the relays operating the single fault conditions.

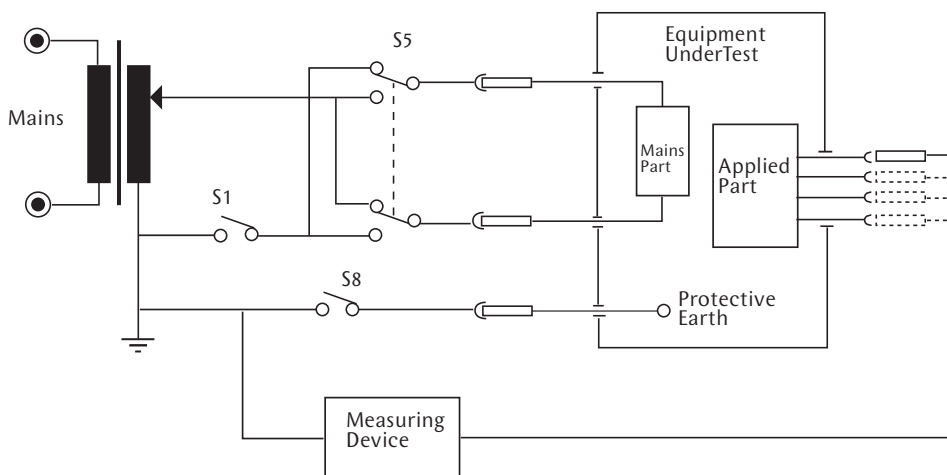

Diagram C - Test Circuit For Patient Leakage Current

Patient Leakage, normal condition - This test measures the patient leakage current under normal conditions. The current is measured through the Measuring Device with S1 and S8 closed, S5 normal and then S5 reversed.

Patient Leakage, single fault, supply open - This test measures the patient leakage current with a single fault condition (supply open). The current is measured through the Measuring Device with S1 open, S8 closed and S5 normal and then S5 reversed.

Patient Leakage, single fault, earth open - This test measures the patient leakage current with a single fault condition (earth open). The current is measured through the Measuring Device with S1 closed, S8 open and S5 normal and then S5 reversed.

Patient Leakage – F-Type

The Patient Leakage F-Type Test (also known as mains on Applied Parts test) displays the current that would flow if a mains potential was applied to the Applied Part which was attached to a patient (i.e. a single fault condition). This test is applied only to type BF and CF equipment.

This test involves applying a current limited mains potential (110% of mains input voltage) to the Applied Parts connections. Due to the requirements for IEC 60601-1 this test current can be in excess of 5mA under short circuit conditions and as such is hazardous to the user. Caution should be taken when conducting this test. Current limiting is via a limiting resistor in series with the measurement circuit.

IEC60601-1 specifies that leakage current for type CF Applied Parts is measured from each of the patient connection / applied parts separately. For type BF equipment the leakage current is measured with all parts of the same type applied parts connected together, shown dotted below.

The F-type Leakage test is valid for both Class 1 and II equipment and are measured under mains normal or reverse and source voltage normal or reverse conditions. *Annex A* shows the pass/fail limits as per IEC 60601-1 requirements.

Diagram D shows a schematic interpretation of the F-Type Leakage measurement including the relays operating the single fault conditions.

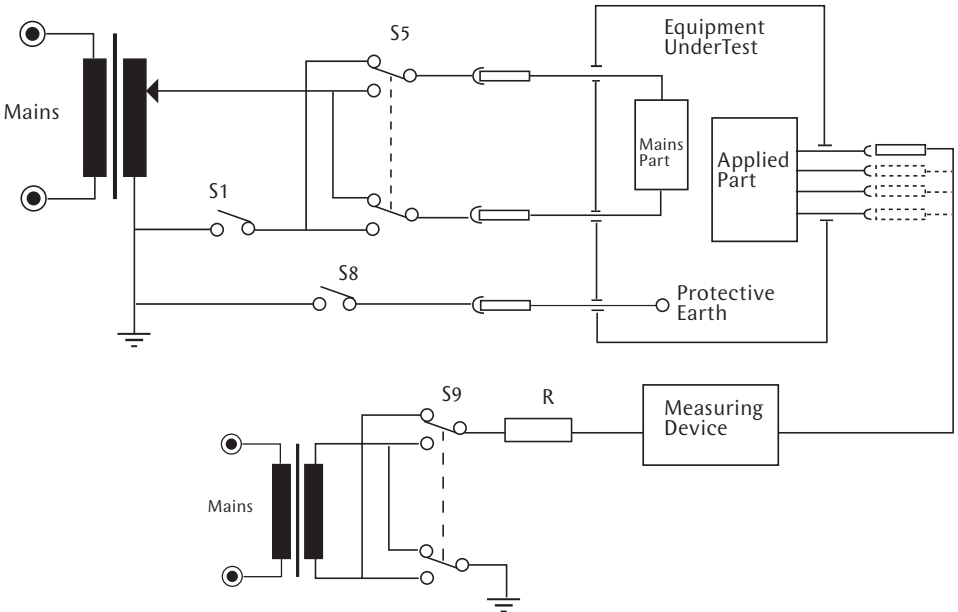

Diagram D - Test Circuit For Patient Leakage Current, Mains On Applied Part

The current is measured through the Measuring Device with S1 and S8 closed. S5 and S9 are switched between normal and reversed.

Patient Auxiliary Current

The Patient Auxiliary Current displays the leakage current that would flow between Applied Parts under normal and fault conditions. For these tests, current is measured between a single part of the applied part and all other applied parts connected together. This test should be repeated until all combinations have been tested. This is also referred to as Applied Part to All.

IEC 60601-1 specifies that the measurements be carried out under normal and reverse operation of the mains supply and single fault conditions Open Neutral circuit and Open Earth. The Patient Auxiliary Leakage test is valid for both Class 1 and II equipment with Types B, BF and CF applied.

Note For Class II equipment, the Single Fault Earth Open tests are not required.

Diagram E shows a schematic interpretation of the Patient Auxiliary Leakage measurement including the relays operating the single fault conditions.

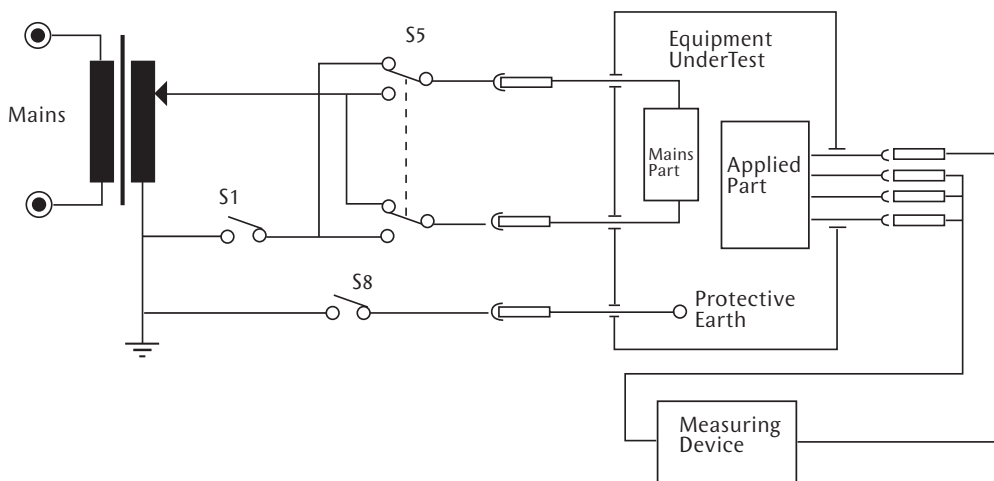

Diagram E - Test Circuit For Patient Auxiliary Current

Patient Auxiliary, normal condition - This test measures the patient auxiliary current under normal conditions. The current is measured through the Measuring Device with S1 and S8 closed, S5 normal and then S5 reversed.

Patient Auxiliary, single fault, supply open - This test measures the patient auxiliary current under a single fault condition (supply open). The current is measured through the Measuring Device with S1 open, S8 closed and S5 normal and then S5 reversed.

Patient Auxiliary, single fault, earth open - This test measures the patient auxiliary current under a single fault condition (earth open). The current is measured through the Measuring Device with S1 closed, S8 open and S5 normal and then S5 reversed.

5. Record Keeping

Currently, manual paper-based systems provide the main method of recording safety testing results in most hospitals. However, as asset management systems gain more favour as a means of tracking equipment, PC-based test records are likely to become more popular in the future. Such systems will enable historical database records to be established to assist in the formulation of preventative maintenance programmes and also contribute to risk assessment calculations.

Test instrument manufacturers, who have already responded with the introduction of instruments capable of storing test results for subsequent downloading to printers, are therefore likely to develop new testers with PC compatible software programmes for records keeping purposes.

Overall, the area of risk assessment and the creation of risk management files has become a growing feature of routine safety testing decisions, with different organisations and departments drawing-up individual plans to deal with specific safety hazards.

For the future, therefore, determining the appropriate levels of electrical testing to be taken without compromising the safety of staff or patients will be central to the introduction of cost effective yet reliable preventative maintenance campaigns.

6. Conclusion

Electrical safety testing of medical electronic devices remains a crucial part of the overall safety validation of medical devices and requires specialised test equipment.

When choosing your electrical safety analyser make sure, firstly, that it can be used to test in accordance with the IEC 60601-1 requirements, and secondly that your analyser will enable you to accurately and repeatedly produce the results you require.

Essential requirements for electrical safety analysers are:

- User safety (never compromise)
- 25Ampere AC earth bond (ground bond) testing up to loads exceeding 0.2 Ohm
- Measuring device meets the frequency response of the IEC 60601-1 body model
- High accuracy and repeatability of leakage measurement readings (Some manufacturers might specify accuracy of full scale reading which will effect the accuracy of low leakage measurements)
- Traceability of measurement results (Do you require data storage?)
- Test convenience (test duration, user interface, can you save time?) and reduce risk of misinterpretation.

Rigel Medical offers a range of test equipment in line with the IEC 60601 requirements. Please visit our website www.rigelmedical.com for a full overview of our product offering or register online for our free newsletter on future product releases and product innovations.

For further questions or comments relating to this booklet or on the Rigel Medical product offering, please contact John Backes via email at johnb@rigelmedical.com

Annex A - IEC 60601-1 Test Limits

Earthbond test limit at 25A, 50Hz

Excluding power cord	< 0.1 Ω					
Including power cord	< 0.2 Ω					
	Type B Applied Parts		Type BF Applied Parts		Type CF Applied Parts	
Leakage Current Type	NC	SFC	NC	SFC	NC	SFC
Earth Leakage (General)	0.5mA	1mA	0.5mA	1mA	0.5mA	1mA
Enclosure Leakage	0.1mA	0.5mA	0.1mA	0.5mA	0.1mA	0.5mA
Patient Leakage (dc)	0.01mA	0.05mA	0.01mA	0.05mA	0.01mA	0.05mA
Patient Leakage (ac)	0.1mA	0.5mA	0.1mA	0.5mA	0.01mA	0.05mA
Patient Leakage (F-Type)	NA	NA	NA	5mA	NA	0.05mA
Patient Leakage (Mains on SIP/SOP)	NA	5mA	NA	NA	NA	NA
Patient Auxiliary Current (dc)	0.01mA	0.05mA	0.01mA	0.05mA	0.01mA	0.05mA
Patient Auxiliary Current (ac)	0.1mA	0.5mA	0.1mA	0.5mA	0.01mA	0.05mA

Annex B - IEC 60601 Body Model

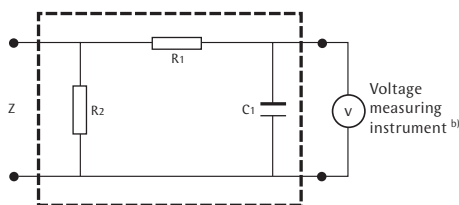

$R_1 = 10 \text{ k } \Omega \pm 5\% \text{ a)}$
 $R_2 = 1 \text{ k } \Omega \pm 5\% \text{ a)}$
 $C_1 = 0,015 \text{ } \mu\text{F} \pm 5\%$

a) Measuring device

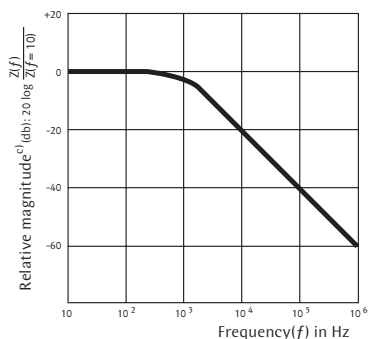

b) Frequency characteristics

NOTE The network and voltage measuring instrument above are replaced by the symbol MD in the following figures

a) Non inductive components
 b) Impedance \gg measuring impedance Z
 c) $Z(f)$ is the transfer impedance of the network, i.e. $V_{out/in}$, for a current frequency f .

Example of a measuring device MD according to IEC 60601-1 and its frequency characteristics

Annex C - Patient Environment

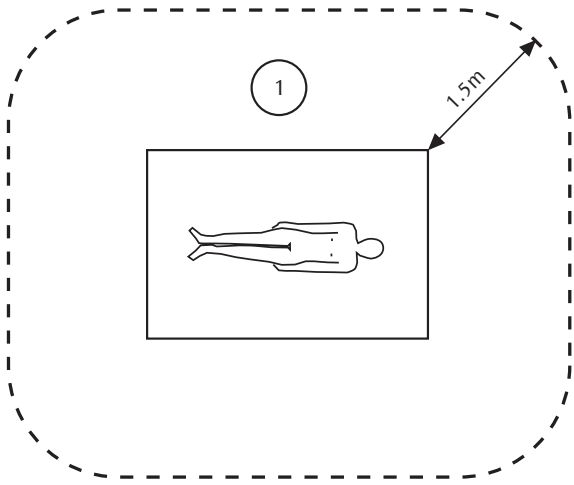
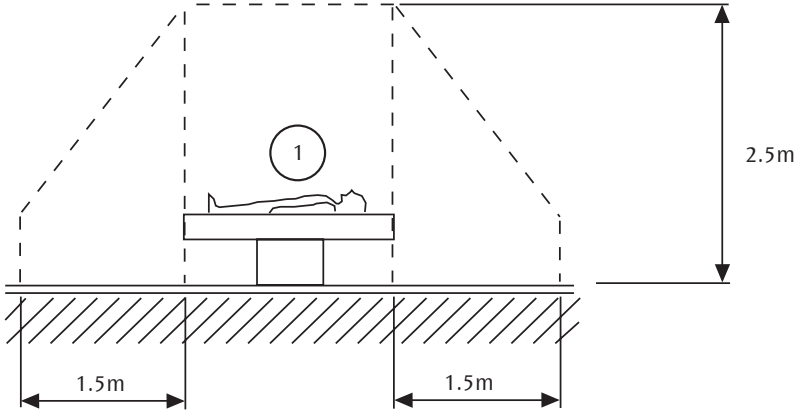

Annex D - IEC 60601 Test Standards

Table 1 – IEC 60601 Collateral Standards
(© IEC Geneva, Switzerland)

IEC 60601-1-1	MEDICAL ELECTRICAL EQUIPMENT – PART 1: GENERAL REQUIREMENTS FOR SAFETY 1: COLLATERAL STANDARD: SAFETY REQUIREMENTS FOR MEDICAL ELECTRICAL SYSTEMS
IEC 60601-1-2	MEDICAL ELECTRICAL EQUIPMENT – PART 1: GENERAL REQUIREMENTS FOR SAFETY 2. COLLATERAL STANDARD: ELECTROMAGNETIC COMPATIBILITY –REQUIREMENTS AND TESTS
IEC 60601-1-3	MEDICAL ELECTRICAL EQUIPMENT – PART 1: GENERAL REQUIREMENTS FOR SAFETY – COLLATERAL STANDARD: GENERAL REQUIREMENTS FOR RADIATION PROTECTION IN DIAGNOSTIC X-RAY EQUIPMENT
IEC 60601-1-4	MEDICAL ELECTRICAL EQUIPMENT: PART 1-4: GENERAL REQUIREMENTS FOR COLLATERAL STANDARD: PROGRAMMABLE ELECTRICAL MEDICAL SYSTEMS

Table 2 – IEC 60601 Specific Standards
(© IEC Geneva, Switzerland)

IEC 60601-2-1	MEDICAL ELECTRICAL EQUIPMENT - PART 2-1: PARTICULAR REQUIREMENTS FOR THE SAFETY OF ELECTRON ACCELERATORS IN THE RANGE 1 MeV TO 50 MeV
IEC 60601-2-2	MEDICAL ELECTRICAL EQUIPMENT - PART 2-2: PARTICULAR REQUIREMENTS FOR THE SAFETY OF HIGH FREQUENCY SURGICAL EQUIPMENT
IEC 60601-2-3	MEDICAL ELECTRICAL EQUIPMENT PART 2: PARTICULAR REQUIREMENTS FOR THE SAFETY OF SHORT-WAVE THERAPY EQUIPMENT
IEC 60601-2-4	MEDICAL ELECTRICAL EQUIPMENT PART 2: PARTICULAR REQUIREMENTS FOR THE SAFETY OF CARDIAC DEFIBRILLATORS AND CARDIAC DEFIBRILLATORS MONITORS
IEC 60601-2-5	MEDICAL ELECTRICAL EQUIPMENT - PART 2-5: PARTICULAR REQUIREMENTS FOR THE SAFETY OF ULTRASONIC PHYSIOTHERAPY EQUIPMENT
IEC 60601-2-6	MEDICAL ELECTRICAL EQUIPMENT - PART 2: PARTICULAR REQUIREMENTS FOR THE SAFETY OF MICROWAVE THERAPY EQUIPMENT
IEC 60601-2-7	MEDICAL ELECTRICAL EQUIPMENT - PART 2-7: PARTICULAR REQUIREMENTS FOR THE SAFETY OF HIGH-VOLTAGE GENERATORS OF DIAGNOSTIC X-RAY GENERATORS
IEC 60601-2-8	MEDICAL ELECTRICAL EQUIPMENT - PART 2-8: PARTICULAR REQUIREMENTS FOR THE SAFETY OF THERAPEUTIC X-RAY EQUIPMENT OPERATING IN THE RANGE 10 kV TO 1 MV
IEC 60601-2-9	MEDICAL ELECTRICAL EQUIPMENT - PART 2: PARTICULAR REQUIREMENTS FOR THE SAFETY OF PATIENT CONTACT DOSEMETERS USED IN RADIOTHERAPY WITH ELECTRICALLY CONNECTED RADIATION DETECTORS
IEC 60601-2-10	MEDICAL ELECTRICAL EQUIPMENT PART 2: PARTICULAR REQUIREMENTS FOR THE SAFETY OF NERVE AND MUSCLE STIMULATORS
IEC 60601-2-12	MEDICAL ELECTRICAL EQUIPMENT PART 2: PARTICULAR REQUIREMENTS FOR THE SAFETY OF GAMMA BEAM THERAPY EQUIPMENT
IEC 60601-2-11	MEDICAL ELECTRICAL EQUIPMENT - PART 2: PARTICULAR REQUIREMENTS FOR THE SAFETY OF LUNG VENTILATORS FOR MEDICAL USE
IEC 60601-2-13	MEDICAL ELECTRICAL EQUIPMENT - PART 2-13: PARTICULAR REQUIREMENTS FOR THE SAFETY OF ANAESTHETIC WORKSTATIONS
IEC 60601-2-14	MEDICAL ELECTRICAL EQUIPMENT - PART 2: PARTICULAR REQUIREMENTS FOR THE SAFETY OF ELECTROCONVULSIVE THERAPY EQUIPMENT
IEC 60601-2-15	MEDICAL ELECTRICAL EQUIPMENT - PART 2: PARTICULAR REQUIREMENTS FOR THE SAFETY OF CAPACITOR DISCHARGE X-RAY GENERATORS
IEC 60601-2-16	MEDICAL ELECTRICAL EQUIPMENT - PART 2: PARTICULAR REQUIREMENTS FOR THE SAFETY OF HAEMODIALYSIS EQUIPMENT
IEC 60601-2-17	MEDICAL ELECTRICAL EQUIPMENT - PART 2: PARTICULAR REQUIREMENTS FOR THE SAFETY OF REMOTE- CONTROLLED AUTOMATICALLY DRIVEN GAMMA RAY AFTER-LOADING EQUIPMENT
IEC 60601-2-18	MEDICAL ELECTRICAL EQUIPMENT PART 2: PARTICULAR REQUIREMENTS FOR THE SAFETY OF ENDOSCOPIC EQUIPMENT
IEC 60601-2-19	MEDICAL ELECTRICAL EQUIPMENT - PART 2: PARTICULAR REQUIREMENTS OF SAFETY OF BABY INCUBATORS
IEC 60601-2-20	MEDICAL ELECTRICAL EQUIPMENT - PART 2: PARTICULAR REQUIREMENTS FOR THE SAFETY OF TRANSPORT INCUBATORS
IEC 60601-2-21	MEDICAL ELECTRICAL EQUIPMENT PART 2: PARTICULAR REQUIREMENTS FOR THE SAFETY OF INFANT RADIANT WARMERS

IEC 60601-2-22	MEDICAL ELECTRICAL EQUIPMENT - PART 2: PARTICULAR REQUIREMENTS FOR THE SAFETY OF DIAGNOSTIC AND THERAPEUTIC LASER EQUIPMENT
IEC 60601-2-23	MEDICAL ELECTRICAL EQUIPMENT - PART 2-23: PARTICULAR REQUIREMENTS FOR THE SAFETY, INCLUDING ESSENTIAL PERFORMANCE, OF TRANSCUTANEOUS PARTIAL PRESSURE MONITORING EQUIPMENT
IEC 60601-2-24	MEDICAL ELECTRICAL EQUIPMENT - PART 2-24: PARTICULAR REQUIREMENTS FOR THE SAFETY OF INFUSION PUMPS AND CONTROLLERS
IEC 60601-2-25	MEDICAL ELECTRICAL EQUIPMENT - PART 2-25: PARTICULAR REQUIREMENTS FOR THE SAFETY OF ELECTROCARDIOGRAPHS
IEC 60601-2-26	MEDICAL ELECTRICAL EQUIPMENT PART 2: PARTICULAR REQUIREMENTS FOR THE SAFETY OF ELECTROENCEPHALOGRAPHS
IEC 60601-2-27	MEDICAL ELECTRICAL EQUIPMENT - PART 2: PARTICULAR REQUIREMENTS FOR THE SAFETY OF ELECTROCARDIOGRAPHIC MONITORING EQUIPMENT
IEC 60601-2-28	MEDICAL ELECTRICAL EQUIPMENT - PART 2: PARTICULAR REQUIREMENTS FOR THE SAFETY OF X-RAY SOURCE ASSEMBLIES AND X-RAY TUBE ASSEMBLIES FOR MEDICAL DIAGNOSIS
IEC 60601-2-29	MEDICAL ELECTRICAL EQUIPMENT - PART 2-29: PARTICULAR REQUIREMENTS FOR THE SAFETY OF RADIOTHERAPY SIMULATORS
IEC 60601-2-30	MEDICAL ELECTRICAL EQUIPMENT - PART 2-30: PARTICULAR REQUIREMENTS FOR THE SAFETY, INCLUDING ESSENTIAL PERFORMANCE, OF AUTOMATIC CYCLING NON-INVASIVE BLOOD PRESSURE MONITORING EQUIPMENT
IEC 60601-2-31	MEDICAL ELECTRICAL EQUIPMENT - PART 2: PARTICULAR REQUIREMENTS FOR THE SAFETY OF EXTERNAL CARDIAC PACEMAKERS WITH INTERNAL POWER SOURCE
IEC 60601-2-32	MEDICAL ELECTRICAL EQUIPMENT PART 2: PARTICULAR REQUIREMENTS FOR THE SAFETY OF ASSOCIATED EQUIPMENT OF X-RAY EQUIPMENT
IEC 60601-2-33	MEDICAL ELECTRICAL EQUIPMENT - PART 2: PARTICULAR REQUIREMENTS FOR THE SAFETY OF MAGNETIC RESONANCE EQUIPMENT FOR MEDICAL DIAGNOSIS
IEC 60601-2-34	MEDICAL ELECTRICAL EQUIPMENT - PART 2: PARTICULAR REQUIREMENTS FOR THE SAFETY, INCLUDING ESSENTIAL PERFORMANCE, OF INVASIVE BLOOD PRESSURE MONITORING EQUIPMENT
IEC 60601-2-35	MEDICAL ELECTRICAL EQUIPMENT - PART 2: PARTICULAR REQUIREMENTS FOR THE SAFETY OF BLANKETS, PADS AND MATTRESSES, INTENDED FOR HEATING IN MEDICAL USE
IEC 60601-2-36	MEDICAL ELECTRICAL EQUIPMENT - PART 2: PARTICULAR REQUIREMENTS FOR THE SAFETY OF EQUIPMENT FOR EXTRACORPOREALLY INDUCED LITHOTRIPSY
IEC 60601-2-38	MEDICAL ELECTRICAL EQUIPMENT - PART 2: PARTICULAR REQUIREMENTS FOR THE SAFETY OF ELECTRICALLY OPERATED HOSPITAL BEDS
IEC 60601-2-39	MEDICAL ELECTRICAL EQUIPMENT - PART 2-39: PARTICULAR REQUIREMENTS FOR THE SAFETY OF PERITONEAL DIALYSIS EQUIPMENT
IEC 60601-2-40	MEDICAL ELECTRICAL EQUIPMENT - PART 2-40: PARTICULAR REQUIREMENTS FOR THE SAFETY OF ELECTROMYOGRAPHS AND EVOKED RESPONSE EQUIPMENT
IEC 60601-2-41	MEDICAL ELECTRICAL EQUIPMENT - PART 2-41: PARTICULAR REQUIREMENTS FOR THE SAFETY OF SURGICAL LUMINAIRES AND LUMINAIRES FOR DIAGNOSIS
IEC 60601-2-43	MEDICAL ELECTRICAL EQUIPMENT - PART 2-43: PARTICULAR REQUIREMENTS FOR THE SAFETY OF X-RAY EQUIPMENT FOR INTERVENTIONAL PROCEDURES
IEC 60601-2-44	MEDICAL ELECTRICAL EQUIPMENT - PART 2-44: PARTICULAR REQUIREMENTS FOR THE SAFETY OF X-RAY EQUIPMENT FOR COMPUTED TOMOGRAPHY
IEC 60601-2-45	MEDICAL ELECTRICAL EQUIPMENT - PART 2-45: PARTICULAR REQUIREMENTS FOR THE SAFETY OF MAMMOGRAPHIC X-RAY EQUIPMENT AND MAMMOGRAPHIC STEREOTACTIC DEVICES
IEC 60601-2-46	MEDICAL ELECTRICAL EQUIPMENT - PART 2-46: PARTICULAR REQUIREMENTS FOR THE SAFETY OF OPERATING TABLES
IEC 60601-2-50	MEDICAL ELECTRICAL EQUIPMENT - PART 2-50: PARTICULAR REQUIREMENTS FOR THE SAFETY OF INFANT PHOTOTHERAPY EQUIPMENT



RIGEL 266 plus

The new Rigel 266 plus is a highly compact, easy-to-use manual Electrical Medical Safety Analyser, designed to test in accordance with IEC/EN 60601-1, MDA DB9801, and AS/NZ 3200.

NIBP SIMULATOR

RIGEL 311

The Rigel 311 is a battery powered, compact non-invasive blood pressure simulator using physiologically correct adult and neonatal waveforms. The Rigel 311 enables you to completely test an NIBP system including the cuff in less than 5 minutes.



SPO2 ANALYSER

RIGEL 322

The Rigel 322 is a battery powered, Pulse Oximetry Analyser, providing complete electronic simulation of most common SPO2 probes. The Rigel 322 is one of the few to contain a full graphic Probe Analyser.

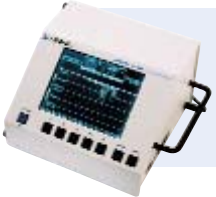

PATIENT SIMULATOR

RIGEL 333

The Rigel 333 Arrhythmia Simulator is a powerful, comprehensive patient simulator with a number of unique features. It provides a full 12 lead ECG signal with more than 40 arrhythmias, dual blood pressure, respiration, and temperature. It also delivers square, sine, and a triangle performance waveforms.



THREE-IN-ONE TESTER

DEFIBRILLATOR / PACEMAKER ANALYSER / ECG ARRHYTHMIA SIMULATOR

RIGEL 344

The Rigel 344 combines the complete testing functions of a defibrillator tester (Mono, Bi-phasic and AED's), a pacemaker analyser (transthoracic & transvenous) and a 12-lead ECG / Arrhythmia simulator into one compact, lightweight, and easy to use instrument.



RIGEL 355

The Rigel is a unique hand-held ventilator tester for both adult and paediatric ventilators. The Rigel 355 offers highly accurate measurements of: Respiration Frequency, Tidal volume, Maximum Pressure, Minimum Pressure, Ventilation, Expiratory average flow, Inspiratory average flow.

