

AC DIELECTRIC TEST SYSTEMS



800kV, 1200KVA AC Dielectric Cylinder Type Transformer used for combined AC/Impulse tests on gas insulated switchgear.



350kV, 700KVA Tank Type Transformer used for testing icing conditions on power network components.

PHENIX AC Dielectric Test Systems are designed and built to perform dielectric testing on cables, switchgear, bushings,

capacitors, fuses, arrestors, motors, etc. to comply with IEEE Standard 4-1995 and IEC Standard 60060.

AC DIELECTRIC TEST SYSTEMS

PHENIX Technologies has been supplying AC Dielectric Test Systems and AC Resonant Test Systems for over 25 years. We have built a reputation as a manufacturer of custom-built test equipment and we strive to design and build systems that meet our customer's exact needs. We have developed expertise in the field of high voltage, high current, and high power. A large percentage of our business has been focused on the development of many types of AC Dielectric Test Sets, including AC Resonant Test Systems and Variable Frequency Resonant Test Systems.

PHENIX Technologies offers a complete line of AC Dielectric Test Sets with output voltage and power ratings to meet all testing requirements. We offer superior reliability and versatility for years of extended service life. Our ISO 9001 Certification ensures the highest in-house quality controls in both the design and

manufacturing process. We have provided AC Dielectric Test Systems to customers around the world to meet and/or exceed their individual testing needs.

Controls

PHENIX offers a choice of four control packages to meet the full spectrum of testing requirements. Our basic models will satisfy many requirements while our state-of-the-art PLC controlled models with Windows™-based software programs provide remote control, data acquisition, automation capabilities, and more for more demanding applications.

Software customization is available for specific requirements not met by standard models.



Customer reference list available upon request.

Applications

Single-phase AC dielectric test sets consist of three major components: The high voltage transformer, voltage regulator, and the control module. They are designed to test within IEEE, IEC and other recognized national and international industry testing standards. Some common test specimens for AC applied voltage are:

- Motors
- Cables
- Switchgear
- Transformers
- Bushings
- Fuses
- Arrestors
- Insulating materials
- Connectors
- HV components
- Transmission Line Hardware
- Capacitors
- and many more applications

PHENIX Offers:

- Experience and highly knowledgeable staff
- ISO 9001 Quality and Reliability Standards
- Windows™-based software
- Automation Options
- Customization Options
- Safety Features
- Longest Warranty in the Industry

COVER PHOTO RIGHT: photo courtesy of "CIGELE-NSERC/Hydro-Quebec/UQAC Chair on Atmospheric icing of Power Network Equipment"

SYSTEM CONTROLS AND SOFTWARE FEATURES

Windows™ Based Software can increase your testing productivity and reliability—The PHENIX AC Dielectric software provides innovative features through an operator-friendly interface. Specific test parameters can be entered or previous test profiles or “recipes” can be recalled for easy test duplication. Test results are graphically displayed to pinpoint real-time voltage, current, step, dwell and duration characteristics. Results can be stored and sorted in a variety of configurations, creating an invaluable test database to recall or printout as needed.

Test Results

Choose to view or print results in either graphical chart format (as shown) or a table format. Real-time graphical display of voltage, current, step, dwell and duration characteristics provide an actual test snapshot for precise, accurate analysis. Customize reports for a concise analysis of results in your preferred format.

Test History

Create and organize your test database for easy test recall and review. Easily search results by entering relevant values in the search field. Results can be sorted by 4 different criteria.

Test Profiles

Create new test profiles by choosing either a custom test, cycle test, or step test format and then selecting a tap value. A window appears to enter specific test criteria, and the test profile is saved and is ready to run or download. Quickly recall previous profiles by either test type, description, or ID value.

Step Test Window

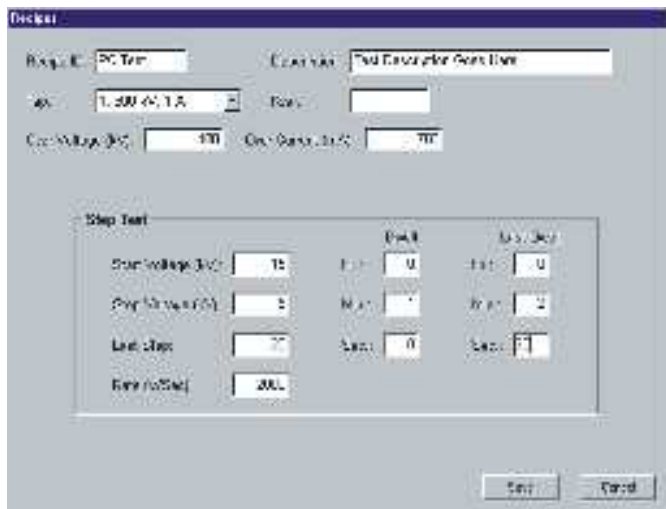

Real-time Graphical Display

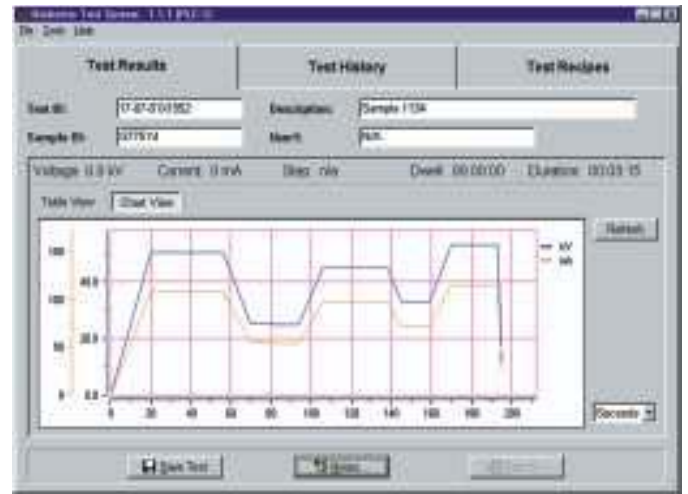

Data Acquisition and Recall

Date	Time	Test ID	Sample ID	Description	Unit
11/01/01	8:20:00 PM	07-07-0101502	070514	070514	MA
11/01/01	8:21:50 PM				
11/01/01	8:13:30 PM				
11/01/01	11:41:30 AM				
11/01/01	11:39:44 AM				
11/01/01	11:37:40 AM				
11/01/01	11:07:18 AM				
11/01/01	11:00:30 AM				
11/01/01	10:54:15 AM				
11/01/01	10:50:45 AM				
11/01/01	10:15:00 AM				

Customized Test Reporting

Step	Voltage	Current	Total	Duration	Step Status
1	50.00V	100.00mA		00:00:00	100%
2	50.00V	100.00mA	00:00:01	00:00:00	100%
3	50.00V	50.00mA	00:00:04	00:01:04	100%
4	50.00V	50.00mA	00:00:02	00:02:06	100%
5	50.00V	75.00mA	00:00:00	00:02:06	100%
6	50.00V	115.00mA	00:00:00	00:03:06	100%
7	50.00V	115.00mA	00:00:00	00:04:06	100%



Standard Metering

- Meter calibration traceable to NIST Standards
- Voltmeters are output-connected, peak responding, calibrated to RMS value.
- Current is measured at the low potential side of the high voltage transformer, and metering is RMS responding.
- Analog Voltmeters are +/- 2% F.S. accuracy
- Digital Voltmeters are +/- (0.8% of reading + 0.2% of range + LSD)
- Analog Ammeters are +/- 3% F.S. accuracy.
- Digital Ammeters are +/- (0.8% of reading + 0.2% of range + LSD)

Burn Feature

The "Burn Feature" is a current limiting choke which is connected in series with the primary winding. This feature offers the ability to burn the faults in the test specimen at a controlled current level. The "Burn Feature" is available with a rating from 25-100% of rated kVA.

Voltage Measurement

Steel tank type units rated over 100 kV usually make use of the bushing with a built-in measuring tap which allows use of

the bushing as a capacitive divider. Cylinder type units up to 350 kV can be supplied with an internal resistive divider. Above 350 kV, units are supplied with free standing capacitive voltage dividers.

**Tank Type
300kV, 350KVA
System**

Current Measurement

The current is measured at the low potential end of the transformer high voltage winding. This is accomplished with either a high accuracy CT or a high precision resistor for lower power applications.



Safety Features

To protect the test set and test specimen from flashovers and short circuits, PHENIX designed an adjustable electronic overload circuit with a total response time of less than 30 milliseconds. The units are furnished with an input circuit breaker and a back-up overload protection in the primary of the high voltage transformer.

Designed with the operator in mind, the following safety features are standard on all test sets:

- Controls in a metal enclosure, with provision for a separate ground lead.

- External interlock provision
- Surge/transient protection on meters and transformers
- Warning Circuit provision (200VA max).
- Overload circuit adjustable from 10% to 110% of rated current; includes indication with reset.
- Main Power Circuit breaker
- Latching emergency off mushroom pushbutton
- Zero-start interlock
- Backup overload circuit in the primary of the high-voltage transformer.



Regulator

The regulator is an air insulated, variable auto-transformer. It is housed in a rugged steel cabinet, including a main input circuit breaker and a contactor for high voltage ON/OFF. A limit switch is also provided for "zero-start interlock." The regulator is normally located close to the main input supply.

For further PHENIX regulator capabilities, refer to our brochure #70105.

Regulator Sizes & Weights

Input Voltage kVA	L	W	H	Weight L			Weight		
				Lbs.	mm	mm	mm	kg.	
220/240 VAC	7.5	22	24	29	200	559	610	737	91
220/240 VAC	10	22	24	29	220	559	610	737	100
380/415 VAC	20	22	24	41	420	559	610	1041	120
440/480 VAC	20	22	24	29	220	559	610	737	100
380/415 VAC	40	22	24	52	630	559	610	1321	230
440/480 VAC	40	22	24	41	420	559	610	1041	191
380/415 VAC	60	32	32	66	980	813	813	1676	445
440/480 VAC	60	22	24	62	630	559	610	1575	410
380/415 VAC	125	42	32	54	52	1067	813	1372	500
440/480 VAC	125	42	32	48	1250	1067	813	1219	490
380/415 VAC	200	42	32	48	1250	1067	813	1219	568
440/480 VAC	200	42	32	42	1200	1067	813	1067	545
380/415 VAC	300	42	32	60	1350	1067	813	1524	614
440/480 VAC	300	42	32	60	1350	1067	813	1067	614

*Must specify voltage **Other Input voltages are available.

TYPES OF AC DIELECTRIC TESTS

PHENIX Technologies offers AC Dielectrics in two fundamental design categories:

- Conventional
- Compensated

Conventional or Compensated?

Which type of AC Dielectric Test Set is appropriate for you depends on both the application, and economics.

For all applications where the capacitive test object also contains a relatively high resistance value, a conventional AC Dielectric Test Set is recommended.

In a Conventional AC Dielectric Test Set the high voltage transformer, the regulator, and therefore the main power input are rated for 100% of the output power of the test set. This type of system is the most versatile in that it will test virtually any type of load.



Cylinder Type Transformer

There are three primary methods of compensation:

- Gapped-Core
- Primary Compensation.
- Resonant Test Systems.

(For further information on Resonant Test Systems please refer to PHENIX brochure #80101)

Gapped-Core AC Dielectric Test Set

In this type of design the input to the high voltage transformer, the regulator, and therefore, the main power is usually sized for 50% of the rated output power.

- The HV transformer is designed with a gap in the magnetic core which provides reactive compensation to cancel out a portion of the capacitive load presented by the test object.
- Under no-load condition and full load conditions, the unit draws full input current.

Primary-Compensated AC Dielectric Test Set

- Inductance introduced into the primary circuit by means of a low voltage reactor.
- Regulator and main input power can be much smaller than the high voltage transformer rating, which is rated for the full output power.

Typical System Components

PHENIX standard line of AC Test Systems designs supplies high voltage for tests of electrical apparatus in accordance with IEC60060, IEEE Standard 4, IEC 60270 test standards.

Designs can be modified to supply:

- A variety of physical configurations suitable for varying installation requirements.
- Mobile Systems.
- Add-on Partial Discharge test and measurement components.
- Customization for production component testing by adding test chambers.

AC Dielectric System Diagram (all Components Supplied By Phenix)

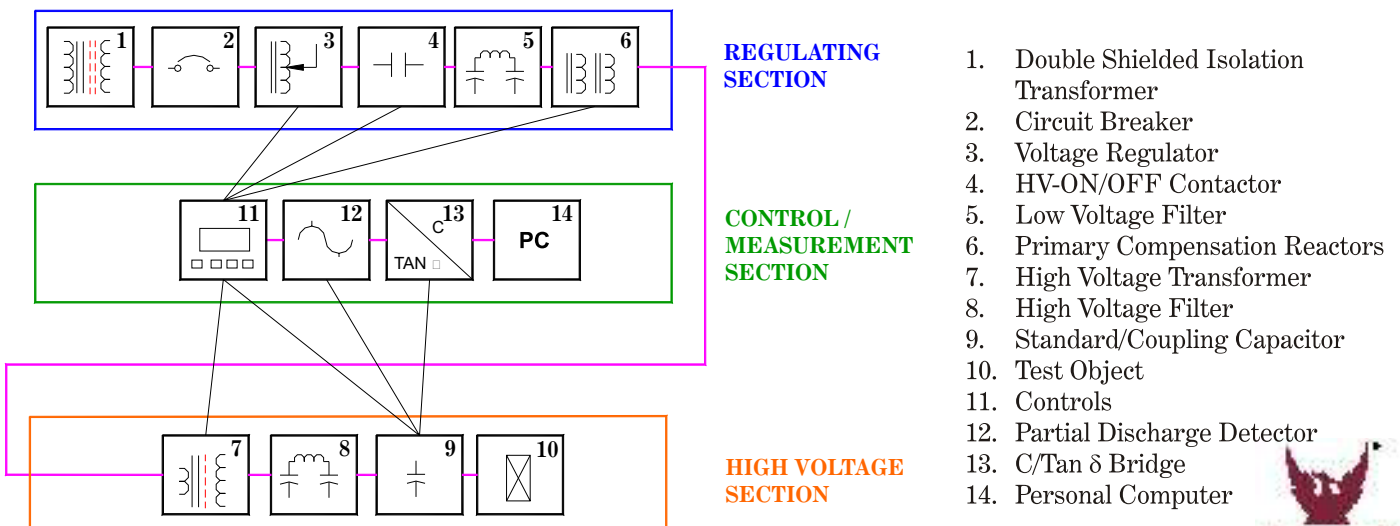

FLEXIBLE SYSTEM CONTROL OPTIONS

PHENIX Technologies offers four control packages designed to meet your testing needs. The Computerized Deluxe (CD) control package offers a large graphics interface display, standard RS-232 port, all of the automatic modes and many other features as shown in the chart below.

The Computerized Standard (CE) package gives you the most affordable solution equipped with standard RS-232 port and pre-programmed automatic modes. The S-series control packages are designed for manual control. The CD or CE display packages enable PC or laptop computer control.

Display Options

Computerized Deluxe (CD)

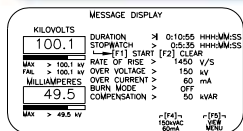

600CD Manual Screen

Computerized Standard (CE)

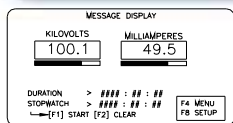

600CE Manual Screen

Standard Digital (SD)



Standard Analog (SA)



Control Features Reference Guide

Controls Type:	SA	SD	CD	CE	PC
Single Range Voltmeter	●	(Dig)	●	●	●
Triple Range Voltmeter	(Ana)	(Dig)	●	●	●
Auto Ranging Voltmeter	●	●	Std	Std	Std
Bar Graph displays % kV	●	●	Std	●	Std
Single Range Currentmeter	Std	Std	●	●	●
Triple Range Currentmeter	Opt	Opt	●	●	●
Auto Ranging Currentmeter	●	●	Std	Std	Std
Bar Graph displays % A	●	●	Std	●	Std
Peak Memory Voltage Meter	●	●	Std	●	Std
Failure Memory Voltage Meter	●	●	Std	Std	Std
Peak Memory Current Meter	●	●	Std	●	Std
Stop Watch	●	●	Std	Std	Std
Burn Mode	Opt	Opt	Opt	Opt	●
Auto Voltage	●	●	Std	Std	Std
Dwell Timer	●	●	Std	Std	Std
Auto Step	●	●	Std	Std	Std
Auto Cycle	●	●	Std	Std	Std
Auto Sequence	●	●	Std	●	Std
Over-Voltage	●	●	Std	Std	Std
Over-Current	●	●	Std	Std	Std
Duration Timer	●	●	Std	Std	Std
Manual Tap Selector	Opt	Opt	Opt	Opt	Opt
Motorized Tap Selector	Opt	Opt	Opt	Opt	Opt
Motorized Regulator	Opt	Opt	Std	Std	Std
Variable Regulator Speed	Std	Std	●	●	●
Variable Ramp Rate	●	●	Std	Std	Std
RS-232 Port	●	●	Std	Std	Std
Graphic Display	●	●	Std	Std	Std

● Feature not available

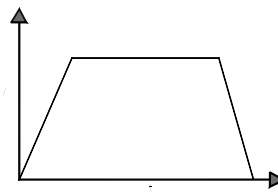

Automatic Voltage with Dwell

One voltage level is maintained for a preset dwell time. When time at set point voltage is equal to the preset dwell time then the test is stopped and output de-energized.

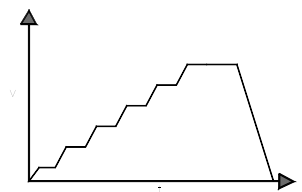

Automatic Voltage Step

This mode steps the voltage up in even voltage increments and dwells at each step for an equal amount of time. The voltage steps up for a predetermined number of steps or until a predetermined maximum voltage level is reached.



Automatic Voltage Cycle

This mode cycles the voltage between two levels. Each voltage level can be set with an independent dwell time. The total test duration can be determined by entering a total number of cycles or entering a total test duration time.



Custom Automatic Voltage Sequence

This mode allows a sequence of one to fifteen different voltage levels to be set with independent dwell times and ramp rates.

Specifications* for Selected HV Transformers** *Figures printed in Burgundy indicate cylinder type transformers*

Custom units up to 2000kV/5MVA are available depending on your exact needs. Please inquire.

Type***	kV	Amps	kVA 1 hr.	Cont.	W mm	In.	L mm	In.	H mm	In.	HT mm	In.	LT mm	In.	Weight kg	Lbs.
D	30	0.250	7.5	5	685	27	685	27	710	28					230	500
A	30	0.667	20.	14	710	28	711	28	735	24	1040	41			362	800
A	30	2.000	60.	42	813	32	711	28	635	25	1143	45			499	1100
D	50	0.150	7.5	5	660	26	660	26	660	26					181	400
D	50	0.200	10.	7	635	25	635	25	660	23					150	330
A	50	0.400	20.	14	711	28	762	30	711	28	1219	48			454	1000
A	50	1.200	60.	42	815	32	865	34	711	28	1118	44			515	1135
A	50	2.500	125.	85	1016	40	864	34	737	29	1245	49			953	2100
D	75	0.100	7.5	5	685	25	685	25	940	37					240	530
A	75	0.267	20.	14	711	28	813	32	762	30	1372	54			499	1100
A	75	0.800	60.	42	813	32	1016	40	914	36	1524	60			1134	2500
A	75	1.667	125.	85	965	38	1016	40	914	36	1524	60			1315	2900
A	75	4.000	300.	210	1270	50	1118	44	1118	44	1727	68			1678	3700
D	100	0.075	7.5	5	686	27	686	27	787	31					227	500
D	100	0.200	20.	14	1092	43	1092	43	1321	52					885	1950
A	100	0.200	20.	14	813	32	1195	47	1067	42	1475	58			680	1500
A	100	0.600	60.	42	965	38	1041	41	1168	46	1525	60			910	2000
A	100	1.250	125.	85	1016	40	1168	46	1219	48	1829	72			1656	3650
A	100	3.000	300.	210	1270	50	1219	48	1270	50	1880	74			1906	4200
B	150	0.050	7.5	5	813	32	1345	53	1321	52	2440	96			1168	2575
B	150	0.133	20.	14	865	34	1320	52	1370	54	2413	95			1406	3100
B	150	0.133	20.	14	1015	40	1015	40	1500	59					815	1800
B	150	0.400	60.	42	965	38	1445	57	1372	54	2490	98			1930	4250
B	150	0.830	125.	85	1118	44	1372	54	1422	56	2464	97			2041	4500
B	150	2.000	300.	210	1372	54	1473	58	1422	56	2464	97			2903	6400
B	200	0.100	20.	14	1040	41	1040	41	1600	63					860	1900
C	200	0.100	20.	14	1016	40	1753	69	1575	62	2743	108	3175	125	2268	5000
C	200	0.300	60.	42	1345	53	1345	53	1625	64	2743	108	3226	127	1905	4200
C	200	0.625	125.	85	1270	50	1778	70	1626	64	2794	110	3251	128	3175	7000
C	200	1.500	300.	210	1626	64	1778	70	1676	66	2946	116	3251	128	4672	10300
C	250	0.240	60.	42	1270	50	1930	76	1829	72	3175	125	3607	142	4037	8900
C	250	0.500	125.	85	1372	54	1981	78	1930	76	3175	125	3607	142	4400	9700
C	250	1.200	300.	210	1626	64	1981	78	1930	76	3200	126	3683	145	5398	11900
E	300	0.066	20.	14	1600	63	1600	63	2133	84					3000	6600
C	300	0.200	60.	42	1321	52	2286	90	2083	82	3810	150	4318	170	5557	12250
C	300	0.417	125.	85	1575	62	2311	91	2184	86	3760	148	5485	216	6970	15360
C	300	1.000	300.	210	1626	64	2311	91	2184	86	3937	155	4318	170	6713	14800

*Chart for general reference only, weights and dimensions may vary with final design, please inquire for more information. **Other ratings available.
 ***Refers to configuration diagram below.
 Specifications subject to change without notice.

HV Transformer Configurations

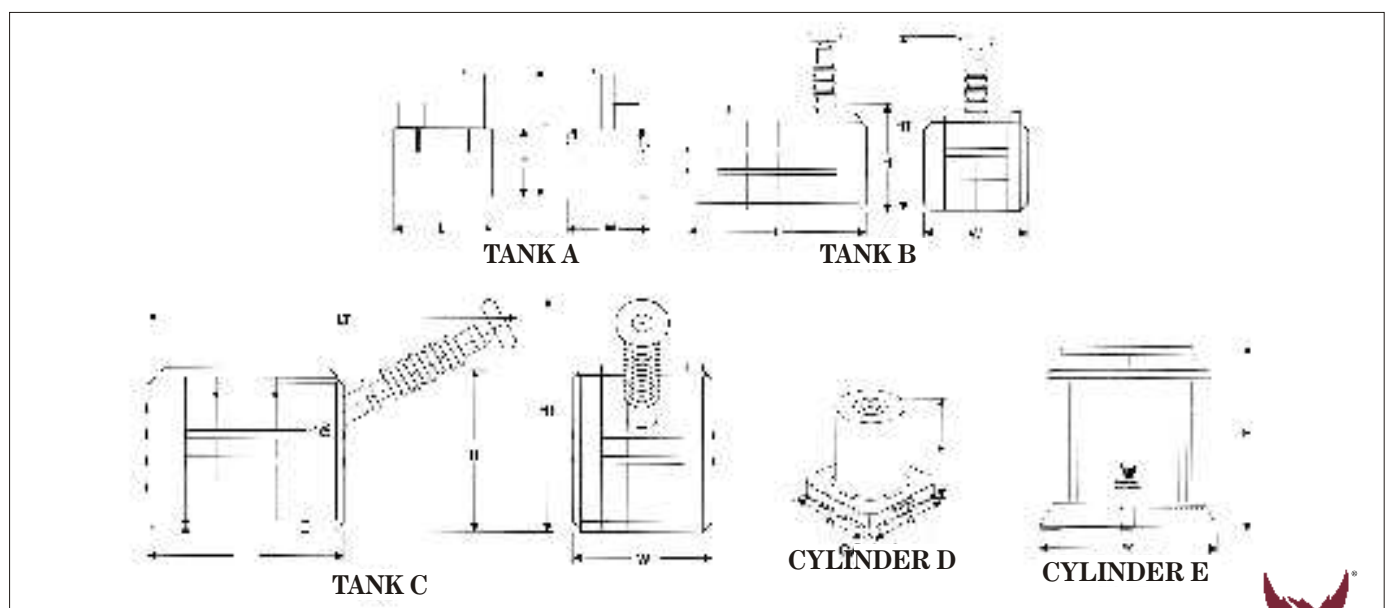

Cables

Shielded, multiconductor control cables (6m/20ft.) are provided for connection between the controls, voltage regulator and high voltage transformer. **NOTE:** the cable between the controls and regulator is only 3m/10ft. when the regulator is not motorized. On units rated at 200kV or higher, the interconnect cables are 9m/30ft. each.

Connectors or terminal blocks for higher power units are mounted on the voltage regulator and high voltage transformer for power interconnection, but non-control power cables must be provided by the customer.

Ground studs are located on the controls, voltage regulator, and high voltage transformer for permanent connection to a station ground.

Quality Assurance

All units are subjected to rigorous factory testing before shipment. A copy of the test report is supplied with each unit. The standard factory test sequence includes:

- Ratio and polarity test.
- Resistance measurement.
- Short-circuit measurement.
- No-load test.
- Meter calibration.
- 110 percent overvoltage test at 2 minutes.
- Flashover test.
- Partial discharge test*

**Standard partial discharge level at full voltage is less than 10 picocoulombs. Lower pd levels are available upon special request.*

Additional System Options

- Control desk
 - a. Single-width pedestal only
 - b. Single-width, with writing table
 - c. Double-width, with writing table
- Casters for high-voltage transformer or regulator
- Partial discharge level less than 5pC or 2pC at full rated output voltage.
- Extra length control cables
- Full kVA taps at various voltage levels (600D & 600C controls only)
- Manual tap selector in HV transformer (standard feature)
- Motorized tap selector in HV transformer
- Units above 200kV with fully rated voltage regulators
- Noise suppressing filter for main supply
- Noise suppressing isolation transformer for main supply
- Protective sphere gap
- Measuring Sphere gap
- High voltage filter
- Standard gas capacitors
- PD & Tan Delta measurements

The PHENIX Technologies Product Line

- High Voltage AC Dielectric Test Sets
- Resonant Test Sets
- Variable Frequency Resonant Test Sets
- DC Hipots and Insulation Test Sets
- Automatic Insulating Material Testers (D149)
- Microhmmeters
- Liquid Dielectric Test Sets
- Megohmmeters
- Vacuum/Oil Interrupter Testers
- Bucket Truck Testers
- High-Frequency Cable Aging Test Sets
- Heat Cycling Test Sets
- Rubber Goods-Protective Equipment Testers
- Core Loss Testers
- AC, DC and AC/DC Motor Test Sets
- Transformer Test Systems
- Frequency Response Analyzer
- High Current / Circuit Breaker Test Sets
- Recloser Test Sets
- DC Power Supplies
- High Voltage DC Cable Thumpers
- High Voltage Terminations
- High Power Column-Type Variable Transformers
- High Power Thoma-Type Variable Transformers
- Voltage and Current Stabilizers

Your local representative is



C/ IKEA, 51 - LOCAL B - 48940 LEIOA - VIZCAYA

TFNO.: 944803040 - FAX: 944348191

Email: isotest@isotest.es

<http://www.isotest.es>



PHENIX
TECHNOLOGIES

75 Speicher Drive

Accident, MD 21520 USA

Tel: 301-746-8118 ● Fax: 301-895-5570